



**DE50F4-XX/1
DE50F4-XX/4
DE50F4-XX/5
GENERATOR**

INSTALLATION AND OPERATORS MANUAL

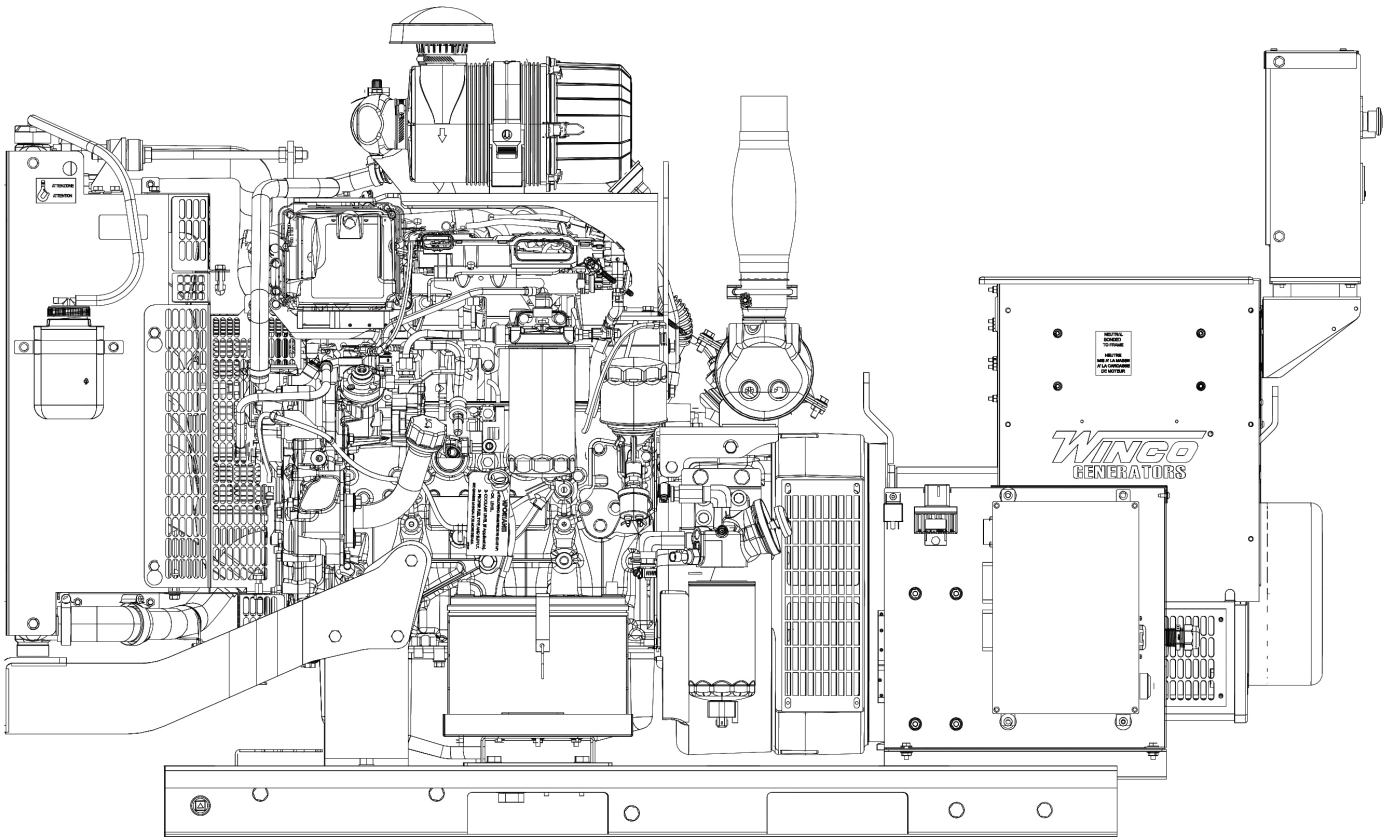

TABLE OF CONTENTS

SAVE THESE INSTRUCTIONS	3	ENGINE CODES	23
SAFETY INFORMATION	4	WIRING SIZE TABLE	29
SAFETY DEFINITIONS		ENGINE HARNESS	30
SPECIFICATIONS	5	CONTROL PANEL WIRING DIAGRAM	31
DE50F4	5	DSE7310 WIRING DIAGRAM	32
INTRODUCTION	6	GENERATOR CONNECTIONS	33
TESTING POLICY		CA EMISSION CONTROL STATEMENT	35
Rated output of generator is based on engineering tests of typical units, and is subject to, and limited by, the temperature, altitude, fuel, and other conditions specified by the manufacturer of applicable engines.		US ENVIRONMENTAL STATEMENT	36
PRODUCT DESCRIPTION		REVALIDATION OF WARRANTY	37
PREPARING THE UNIT	7	LIMITED WARRANTY	38
START-UP CHECK LIST			
UNPACKING			
LIFTING THE GENERATOR SET			
INSTALLATION	8		
GENERAL INFORMATION			
ENGINE GENERATOR SET MOUNTING			
VENTILATION REQUIREMENTS			
EXHAUST INSTALLATION			
FUEL INSTALLATION			
INSTALLING THE FUEL LINE			
ELECTRICAL CONNECTIONS			
GENERATOR CIRCUIT BREAKER			
LOAD BALANCING			
GROUNDING			
TRANSFER SWITCH			
DC WIRING			
INSTALLING THE BATTERY	13		
SERVICING BATTERIES			
BATTERY CHARGER & BLOCK HEATER			
STARTING PROCEDURE	15		
LUBRICATION			
COOLANT			
PRE-START CHECK LIST			
MANUAL START PANEL			
DSE7310 MKII			
CONTROL POWER			
OPERATING CONDITIONS	19		
NORMAL OPERATION			
HARSH ENVIRONMENTS OPERATIONS			
COLD WEATHER OPERATIONS			
MAINTENANCE	20		
CHANGING THE OIL			
CHANGING OIL FILTER			
REFILLING COOLANT			
CHANGING AIR FILTER			
CHECKING WATER IN PRE-FILTER			
CLEANING RADIATOR			
REPLACING BLOW-BY FILTER			
STORAGE			
MAINTENANCE SCHEDULE			
TROUBLE SHOOTING TABLES			

SAVE THESE INSTRUCTIONS

This manual contains important instructions that should be followed during installation and maintenance of the generator. Read and understand all instructions in the manual before starting and operating the generator.

USING THIS MANUAL

Congratulations on your choice of a WINCO generator. You have selected a high-quality, precision-engineered generator designed and tested to give you years of satisfactory service.

To get the best performance from your new generator, it is important that you carefully read and follow the operating instructions in this manual.

Should you experience a problem please follow the "Troubleshooting Tables" near the end of this manual. The warranty listed in the manual describes what you can expect from WINCO should you need service assistance in the future.

COPY YOUR MODEL AND SERIAL NUMBER HERE

No other WINCO generator has the same serial number as yours. If you should ever need to contact us on this unit, it will help us to respond to your needs faster.

MODEL _____

SERIAL NUMBER _____

PURCHASE DATE _____

DEALER NAME _____

DEALER PHONE # _____

SAFETY INFORMATION

IMPORTANT SAFETY INSTRUCTIONS

This engine generator set has been designed and manufactured to allow safe, reliable performance. Poor maintenance, improper or careless use can result in potentially deadly hazards; from electrical shock, exhaust gas asphyxiation, or fire. Please read all safety instructions carefully before installation or use. Keep these instructions handy for future reference. Take special note and follow all warnings on the unit labels and in the manuals.

CALIFORNIA PROPOSITION 65



WARNING: This product contains crude oil, gasoline, diesel fuel and other petroleum products, Antifreeze to which can expose you to chemicals including toluene and benzene, Ethylene glycol (ingested) which are known to the State of California to cause cancer, birth defects or other reproductive harm and developmental issues. For more information go to www.P65Warning.ca.gov.

SAFETY DEFINITIONS

DANGER	Indicates an imminently hazardous situation which, if not avoided, will result in death or serious injury.
WARNING	Indicates a potentially hazardous situation which, if not avoided, could result in death or serious injury.
CAUTION	Indicates a potentially hazardous situation which, if not avoided, may result in minor or moderate injury. It may also be used to alert against unsafe practices.

DANGER: ELECTRICAL SHOCK

The output voltage present in this equipment can cause fatal electric shock. This equipment must be operated by a responsible person.

- A. Do not allow anyone to operate the generator without proper instruction.
- B. Guard against electric shock.
- C. Avoid contact with live terminals or receptacles.
- D. Use extreme care if operating this unit in rain or snow.
- E. Use only three-pronged grounded receptacles and extension cords.
- F. Be sure the unit is properly grounded, installation must meet the national electrical code.

DANGER: DEADLY EXHAUST GAS

Exhaust fumes from any gasoline engine contain carbon monoxide, an invisible, odorless and deadly gas that must be mixed with fresh air.

- A. Operate only in well ventilated areas.
- B. Never operate indoors including attached garages
- C. Never operate the unit in such a way as to allow exhaust gases to seep back into closed rooms (i.e. through windows, walls, floors).

DANGER: FIRE HAZARD

Gasoline and other fuels present a hazard of possible explosion and/or fire.

- A. Do not refuel when the engine is running or hot.
- B. Keep fuel containers out of reach of children.
- C. Do not smoke or use open flame near the generator set or fuel tank.
- D. Keep a fire extinguisher nearby and know its proper use. Fire extinguishers rated ABC by NFPA are appropriate.
- E. Store fuel only in an approved container, and only in a well ventilated area.
- F. Follow local codes for closeness to combustible material.

CAUTION: NOISE HAZARD

Excessive noise is not only tiring, but continual exposure can lead to loss of hearing.

- A. Use hearing protection when working around this equipment for long periods of time.
- B. Keep your neighbors in mind when using this equipment.

CAUTION

Keep the generator and surrounding area clean.

- A. Remove all grease, ice, snow or materials that create slippery conditions around the unit.
- B. Remove any rags or other materials that could create a potential fire hazard.
- C. Carefully clean up any gas or oil spills before starting the unit.
- D. Do Not use the generator area as a storage closet.

CAUTION

All service, including the installation or replacement of service parts, should be performed only by a qualified technician.

- A. Use only factory approved repair parts.
- B. Do not work on this equipment when fatigued.
- C. Never remove the protective guards, covers, or receptacle panels while the engine is running.
- D. Use extreme caution when working on electrical components. High output voltage from this equipment can cause serious injury or death.
- E. Always avoid hot mufflers, exhaust manifolds, and engine parts. They can cause severe burns instantly.
- F. The use of the engine-generator set must comply with all national, state, and local codes.

SPECIFICATIONS

DE50F4

VOLTS	PF	STANDBY			PRIME		
		WATTS	KVA	AMPS	WATTS	KVA	AMPS
120/240 1-PH	1.0	45,000	45	187	40,500	40.5	168
120/208 3-PH	0.8	47,000	60	166	43,200	54	150
120/240 3-PH	0.8	47,000	60	144	43,200	54	130
277/480 3-PH	0.8	47,000	60	72	43,200	54	65
346/600 3-PH	0.8	47,000	60	58	43,200	54	52

GENERATOR RESISTANCE (all value at 22°C)

Model	Stamford UCI224E
Winding Group	311
Rotor	0.69 Ω
Stator	0.101 Ω
Exciter Rotor	0.078 per phase Ω
Exciter Stator	20.0 Ω

ENGINE

Model	FPT F34 ESZW01
Starting System	12 Volt
Fuel Consumption (full load)	4.16 Gal/hr
Fuel	ASTM D-975 - 2D*
Oil Type	See Lubrication section in this manual
Oil Capacity	10 Quarts
Cooling System	50/50 mix

* See engine manual for additional fuel types and specifications

INTRODUCTION

TESTING POLICY

Before any generator is shipped from the factory, it is fully checked for performance. The generator is loaded to its full capacity, and the voltage, current, and frequency are carefully checked.

Rated output of generator is based on engineering tests of typical units, and is subject to, and limited by, the temperature, altitude, fuel, and other conditions specified by the manufacturer of applicable engines.

PRODUCT DESCRIPTION

The engine-generator set consists of a multi-cylinder, liquid-cooled engine nominally operating at 1800 RPM. This generator set meets current EPA regulations for standby or prime power use. The generator frequency regulation is maintained by the engine electronic governor to within +/- 0.5 Hertz. The generator is connected to the engine flywheel via flexible drive disks. The generator set is skid mounted with isolation mounts between the engine and base.

NOTICE:

A Customer supplied 12 Volt battery is required to complete the installation. Battery requirements are listed later under the battery installation section.

The generator ships with an advanced DSE7310 digital controller. The DSE7310 will electronically display useful engine and generator performance information. The controller starts and stops the generator and monitors critical operating parameters and will shut the generator down to protect the engine from damage.

GENERATOR SET:

Every WINCO generator set has its own unique identity data plate. This data plate identifies the complete unit model number, the system serial number, and has links to the individual components that form the generator set in our factory records. Several of the major components also have their own individual data plates providing additional information to document build data for warranty and replacements parts. Be sure to have the main WINCO unit data plate information recorded inside the front cover of this manual for future reference and for identification whenever requesting field or factory assistance.
Primary fields needed for assistance are complete model number and serial number.

ENGINE:

This manual covers specific operation of the combined engine generator set. The basic engine information provided in this manual is not suitable for all operating conditions. Refer to the engine operators manual for more detailed operation and maintenance information.

CAUTION: EQUIPMENT DAMAGE

Be sure to check the engine oil level frequently as specified in the engine manual.

The engine manufacturer has established an excellent worldwide engine service organization; engine service is available from a nearby authorized dealer or distributor. Go to the WINCO website for a list of engine dealers (wincogen.com) or contact the WINCO Service Department.

The rated power of each engine-generator is limited by the temperature, altitude, and all other ambient conditions specified by the engine manufacturer.

Derates

Above Sea Level	
6,561 FT	10%
9,842 FT	20%
<hr/>	
Coolant Temperature	
>104°F	3% per 10°F

Units should not be operated in ambient temperature greater than 125° Fahrenheit.

GENERATOR:

The nameplate includes a standby and prime/continuous rating. The standby rating is the maximum amount of power the generator set can produce. For prime power applications the load should be equal to or less than the prime power rating and the load is assumed to be variable. It is acceptable to occasionally reach the standby rating during prime operation to start motors or other temporary surges.

WINCO generator sets use a brushless, AVR (Auto-Voltage Regulator) controlled broad-range generator ends. The generator converts rotational mechanical energy into electrical energy. These WINCO units are equipped with generators manufactured by Cummins Generator Technologies. Each generator 'end' has its own data tag. A unique serial number is on the data plate and the data label is affixed to the main frame on the generator on the left side.

PREPARING THE UNIT

START-UP CHECK LIST

A Start-Up Completion & Warranty Validation Form was sent along with this manual. This must be completed and returned to WINCO Inc. within 180 days of the factory invoice date. If this form is not returned, the Warranty may be voided.

UNPACKING

1. As you receive your unit, it is critical to check it for any damage. If any damage is noted, it is always easiest to refuse the shipment and let WINCO take care of the freight claim. If you sign for the unit, the transfer of the ownership requires that you file the freight claim
2. Before proceeding with the preparations of your new generator for operation, take a couple of minutes to ensure the unit you have received is the correct model and review the specification pages in this manual to ensure that this unit meets your job requirements.

CAUTION: EQUIPMENT DAMAGE

These units are shipped with oil and a 50/50 mix of coolant. Be sure to check all fluid levels before operating. See engine manufacturer's instruction manual for recommended oil requirements before initial starting.

Once generator set is on-site:

1. Carefully remove the crate.
2. After inspecting the engine-generator for external, physical damage, locate and check the following items packed with the unit:
 - a. Installation and Operator's Manual.
 - b. Engine manufacturer's instruction manual.
 - c. Start-up and warranty validation form.
 - d. Battery hold-down brackets & hardware.
 - e. Unit components or accessory items shipped loose for on-site installation.
 - f. Optional accessories.
3. Remove main frame hold-down bolts.
4. Unit can now be lifted from shipping rails.

LIFTING THE GENERATOR SET

NOTICE: PERSONAL INJURY

To prevent injury to persons or equipment, observe the following guidelines when lifting the generator:

CAUTION

Do not attempt to lift the generator set by the means of the lifting eyes on the engine or generator end. These lifting points are only for the use during the manufacturing process and are designed for lifting of the individual generator set components and not the complete unit.

WARNING

NEVER attempt to lift the fuel tank filled with fuel. Sloshing of the fuel can cause a shift in the balance of the fuel tank, making for a DANGEROUS, unbalanced lifting load. If the generator was shipped on the fuel tank, use the lifting points located on the fuel tank to move the entire generator set into place. **DO NOT PLACE FUEL IN THE TANK PRIOR TO LIFTING.**

This generator set is equipped with integrated fork pockets to allow the generator to be lifted from any side.



Always use forklifts of a proper rating and with long enough forks to move the generator. As the distance from the forklift forks mast increases the lifting capacity for the forklift decreases. When lifting from the side the forks should extend the entire width of the unit through the opposite side frame rail.

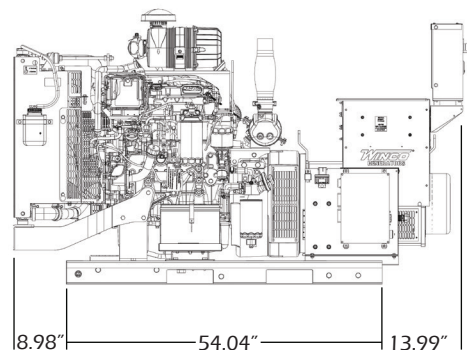
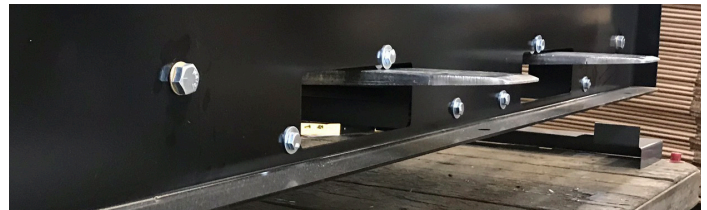

CAUTION: EQUIPMENT DAMAGE

It is possible to lift the generator from the radiator side. It requires especially long forks and care should be taken to ensure that no contact is made with the radiator. Pushing the radiator will cause damage that is not covered under warranty.

INSTALLATION

The max ambient temperature is 125°F. For derating information, see specification sheet. This unit should be installed in a well ventilated area, ensuring the exhaust air cannot be recirculated back into the engine

CAUTION

This unit will get hot while it is running and for some time afterward.

WARNING: PERSONAL INJURY

Before proceeding with the installation, be sure the engine control is in the "stop" position and the emergency stop depressed. Also, be sure the generator MLCB (main line circuit breaker) is in the "off" position and the unit starting battery is disconnected.

GENERAL INFORMATION

This series of engine-generator sets are designed and built as open power units, meaning no weather protection has been provided. These units must be installed inside of an enclosure that will provide proper protection from the elements.

The WINCO installation manual OPM-112 contains additional information on indoor installations and is available electronically through our website or by requesting a copy from the factory.

Before beginning the installation process, recheck the voltage, phase, and amperage rating of the generator set. Be certain it can handle the intended load and are compatible with the intended loads. Plans for installation should be prepared with proper attention to mechanical and electrical engineering detail to assure a satisfactory system installation. The installation must comply with all national, state, and local codes.

The information in this manual is offered only as a guide to finalizing your installation plans and does not substitute for sound engineering judgment for the specific application.

ENGINE GENERATOR SET MOUNTING

The unit's main frame must be bolted securely to a solid base. The engine-generator is mounted on channels which are attached with special shock mounts to the main frame. This allows the engine-generator free movement without affecting the base or surrounding equipment.

WARNING: EQUIPMENT DAMAGE

Never mount these engine-generator sets to a wooden base/structure. Over time, the wood will deteriorate and the unit mountings will come loose. These units must be mounted to a steel or concrete base.

VENTILATION REQUIREMENTS

WARNING: EQUIPMENT DAMAGE

It is the installer's responsibility to ensure that there is sufficient cooling air available to prevent the engine and generator from over heating. Damage caused by overheating is not covered by warranty.

Providing proper air movement during your installation planning is essential. You will need to provide a fresh air inlet as well as a hot air outlet (to the outside of protection housing) for proper engine performance. These engine-generator sets are equipped with unit mount radiators and the engine is equipped with a pusher type fan. The hot air from the face of the radiator must be ducted out of the enclosure to ensure proper cooling. Failing to do so will allow the hot air to recirculate around the radiator causing the engine to overheat, resulting in an engine shutdown and damage. If louvers are used in front of the hot air duct to protect the unit from outside weather, the louvers should be 1 ½ times as large as the area of the radiator face to prevent back pressure.

The radiator or duct flange should not be placed closer than 0.75 in. to the edge of the structure or other solid surfaces. The radiator is mounted on rubber vibration isolators that allow it to move. Placing the duct flange too close to a wall can result in contact that will damage the radiator resulting in costly repairs.

Foam or other seals can be used to form a tight lip forcing all of the air from the engine fan out of the enclosure. In addition to a hot air discharge, you must plan a fresh air intake opposite the radiator discharge.

WARNING: EQUIPMENT DAMAGE

Failure to seal the radiator output will result in hot air recirculation that will result in equipment overheating and damage.

Their fresh air inlets should be 1 ½ to 2 times larger than the radiator face. The extra air inlet area is required to minimize restriction and to provide combustion air for the engine. Do not block fresh air intakes with other equipment as this will result in insufficient air flow to the engine for cooling. Installing them opposite the hot air discharge will allow a sweeping flow of cooling air across the engine, preventing hot spots.

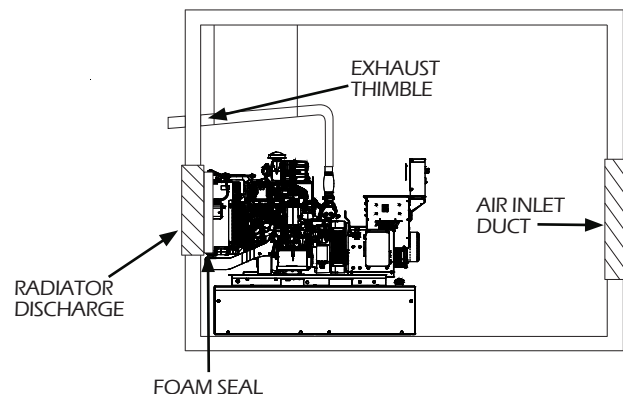

EXHAUST INSTALLATION

DANGER: PERSONAL INJURY

Improper exhaust installation will allow dangerous gases to seep into enclosed spaces causing a hazard to your health and/or death.

All exhaust must be piped out of the enclosure. When selecting a location to exhaust fumes make sure that the potential for contact with people is controlled. Exhaust can enter buildings through windows, ventilation systems and other openings if proper precautions are not followed.

The exhaust must be isolated from the vibration of the engine. If the exhaust is connected in a rigid system it will result in damage to the engine. The generator comes equipped with an engine mounted flex pipe to aid your installation. Ensure proper alignment with the generator. The flex can be eliminated if it is pushed to one side to make a connection.

The most direct path possible should be used to get to the outside of the enclosure. Each bend restricts the pipe and increases back pressure. It may be necessary to increase the exhaust pipe diameter in some applications.

The exhaust pipe is very hot. When passing through the structure it is critical that a thimble or other appropriate technique is used to dissipate the heat and prevent the structure from catching on fire.

Water in the exhaust pipe and especially the Diesel Oxidation Catalyst (DOC) will cause damage to the engine. It is preferable to exhaust out the side of the enclosures. Slope the pipe slightly downward away from the engine to cause any water in the exhaust to run away from the engine. Do not exhaust near intake. Once outside the enclosure a rain cap or other technique must be used to keep water out of the exhaust. In mobile applications make sure the rain flap faces to the rear of the vehicle so that it is not blown open during transportation.

In many applications the DOC works as the muffler. If it is desired to decrease engine noise further adding a muffler to the exhaust system is possible. The muffler cannot increase back pressure to more than 0.725 psi.

FUEL INSTALLATION

The fuel supply should be as close to the engine as possible. This will reduce the installation cost of fuel runs and minimize line losses. The diesel fuel supply should be no more than 3 feet below the fuel inlet pump. If your fuel supply is lower than 3 feet, you may have to install an additional lift pump to bring the fuel up to the mechanical fuel pump on the engine.

The information in this manual is offered to assist you in providing the proper fuel for your engine. However, this information is only provided to inform you of the engine's requirements and assist in making you aware of the decisions you must make. In no case should the instructions or information provided be interpreted to conflict with any local, state, or national codes. If in doubt, always consult your local fire marshal or fuel supplier.

INSTALLING THE FUEL LINE

Engine-generator sets are properly adjusted before they leave the factory. Connecting a fuel supply with adequate supply volume is critical to reliable operation. Diesel units with optional base mounted fuel tanks are pre-plumbed to the mechanical fuel pump on the engine.

Open skid mounted diesel units are often supplied with capped inlet and return lines. The use of a suitable customer supplied flexible fuel lines is essential between the engine and fuel supply to provide a vibration break between your fuel supply and the engine.

WARNING: FIRE DANGER

Connecting rigid fuel line (i.e. steel or copper line) directly to the inlet fuel filter or fuel pump may cause the fuel line to crack during operation creating a serious fire hazard.



Fuel Return
Line Connection

Fuel Inlet
Connection

ELECTRICAL CONNECTIONS

NOTICE: CLASS 1 WIRING METHODS ARE TO BE USED FOR ALL FIELD WIRING CONNECTIONS TO TERMINALS OF A CLASS 2 CIRCUIT

NOTE: The symbol  always indicates ground where shown. All wiring must be completed in accordance with the National Electric Code as well as any state and local codes.

You must pay particular attention to wire size requirement for the amperage of service you are dealing with. The table below provides you guidance on wire sizing based on both wire type and amperage. Wire amperages have been derated for 40° C ambient temperatures operation.

GENERATOR CIRCUIT BREAKER

This unit DOES NOT come with a circuit breaker. The circuit breaker will provide overload protection for the generator.

The following table gives you the recommended circuit breaker size specifications. See actual breaker for wire capabilities and torque specifications and restrictions.

Watts	Voltage	Phase	CB AMP
45,000	120/240	1	200-225
47,000	120/208	3	150-200
47,000	120/240	3	150-175
47,000	277/480	3	60-90

The wire must be properly sized between the generator and the load. Use the table 310-16 of the National Electrical Code ANSI/NFPA 70. to properly size the wire to meet or exceed the amperage rating of the circuit breaker installed.

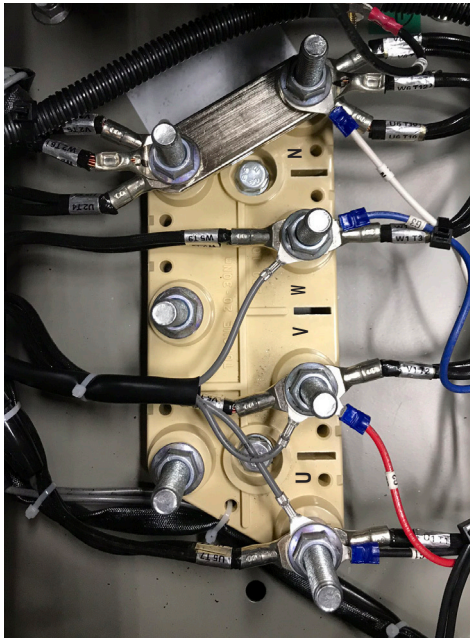

Lug size 10mm

CUSTOMER CONNECTIONS

U	Line 1
V	Line 2
W	Line 3
N	Neutral
⏚	Ground

The DSE 7310 controller uses current transformers (CT) to monitor the amount of load on each leg of the generator. If the wires are routed through the CT the wrong direction it will result in a negative current readings on the controllers. This can be corrected by swapping the wires on the CT terminals in the generator end. Zip tie the wires to the CT walls after installation in order to prevent wire movement.

WARNING: PERSONAL DANGER

These units are shipped with a NEUTRAL TO GROUND BOND INSTALLED. If your system already has a neutral to ground bond, then you must run a separate ground lead to that location and UNBOND THE JUMPER IN THE CONNECTION PANEL. For additional information, refer to the current National Electrical Code on grounding.

WARNING: EQUIPMENT DAMAGE

When installing a three phase 240 Volt system, be sure you know which lead is high voltage 'wild' leg (208 Volt to neutral). The generator normally carries the high voltage on the G2 lead.

LOAD BALANCING

The following diagram represents this generator when configured in single phase. A and B represent the 120V output of this generator. Up to **half** of the rated capacity can be drawn from the L1 to N or L2 to N. This generator's full capacity can be drawn from C by connecting the load at 240V from L1 to L2. Remember that power from C equally reduces the amount of power available at both A and B and vice versa.

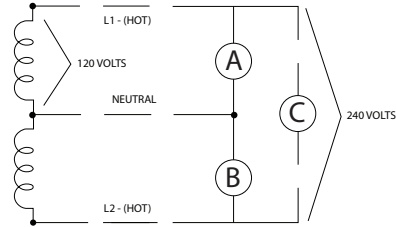

The following diagram represents the generator when configured in 3-phase. A, B, and C represent the L to N voltage output of this generator. Up to a **third** of the rated capacity can be drawn from L1, L2, or L3 to N. This generator's full capacity can be drawn from D by connecting a 3-phase load to all three legs. Remember that power taken from D equally reduces the amount of power available to both A, B, and C and Vice versa.

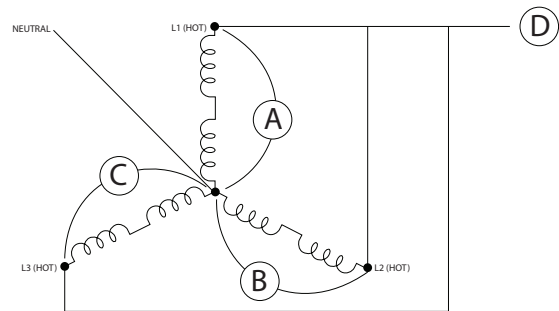

When connecting loads to the generator, make sure you balance the amount of load on each leg. Equipment, like motors, evenly load on each leg (two leg for 1-ph and three legs for 3-ph) and do not require any special considerations for load balancing. When applying 1-ph loads to 3-ph systems, care must be taken to ensure that each leg is equally balanced. A sign of unbalanced loads may be trouble with voltage regulation. The generator's nameplate current ratings are calculated using a 0.8 power factor (PF). Many loads are applied at 1.0 PF, reducing the total amperage available. Use the following formula to calculate the current required for your loads.

$$\text{Amps} = \frac{\text{Watts}}{(1.732 \times V \times \text{PF})}$$

WARNING: EQUIPMENT DAMAGE

Unbalanced loads can lead to overloading of individual winding groups and high voltage swings. This may result in equipment damage if the unbalance is left uncorrected.

GROUNDING

Proper grounding of your generator is application dependent. Carefully evaluate your planned use of your generator to understand which grounding you require. If you are not sure what to do, contact a competent professional to assist you. The NFPA 70 250:34-35 are good technical references.

VEHICLE-MOUNTED GENERATOR

Your WINCO generator ships with a bonded neutral. When mounted to a vehicle to safely distribute power it is necessary that the generator frame is bonded to the vehicle frame. The generator should only supply equipment that is cord and plug connected through customer installed receptacles mounted on the generator or the vehicle.

PERMANENTLY INSTALLED GENERATORS

This WINCO portable generator ships with a bonded neutral. NFPA 70 refers to this as a "separately derived system." When connecting it to a building a transfer switch specifically designed for GFCI and bonded neutral generators is required or the ground or the neutral to ground bond must be broken and the panel relabeled.

TRANSFER SWITCH

NOTICE

For full service switching of the entire load, the ATS must be 'SE' (Service Entrance) rated or must have a properly rated fusible disconnect installed before the ATS to protect the contacts.

WARNING: FIRE HAZARD

All wiring must be done by a licensed electrician, and must conform to the National Electrical Code and comply with all the local codes and regulations. Check with the local authorities before proceeding.

INSTALLATION NOTES:

Because of many different types of service, feeder and distribution equipment, no specific wiring instructions can be provided. It is recommended that only copper wire be used. In all cases it is essential that while the load is connected to the generator, there can be absolutely no feedback from the generator to the power line or the power line to the generator. When properly installed, the normal ATS Control and safety system will eliminate all paths and feedback.

To wire the automatic transfer switch into existing wiring, first determine which circuits will be on the emergency load circuit. If the entire load is transferred, the transfer switch can be wired directly after the meter and the service entrance, providing the service entrance ampere rating is within the transfer switch's rated capability.

If only specific circuits are to be powered under emergency power failure conditions, an additional distribution panel designated "emergency distribution panel" must be installed.

All selected emergency circuits are removed from main distribution panels and installed in the emergency distribution panel. The ATS is then installed between the main panel and the emergency distribution panel. Suggested circuits: freezer, refrigerator, furnace, emergency lights, sump pump, emergency outlet circuits, etc. Total running load must not exceed generator rating.

DC WIRING

All communication and DC wiring should be run in separate conduit from AC wiring.

To install the wires, reference the following picture. Use a small flat head screwdriver to push the release spring inside the square hole (A). While the release is being pushed, insert the wire into the larger circular hole (B). Remove the screwdriver to secure the wire into place.

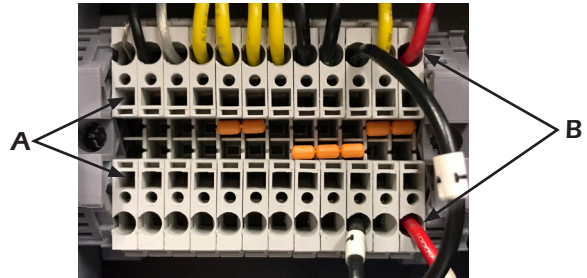

REMOTE START

The DSE7310 is able to start the generator when it receives a remote signal from any dry contact. This makes the system compatible with a wide range of control mechanisms including two-wire start automatic transfer switches. When the contact closes the controller will automatically start. When the contact is opened the generator will go through a cool-down cycle and turn off. Connect the remote start leads to the Remote Start + and Remote Start - terminal blocks in the door behind the DSE 7310 controller.

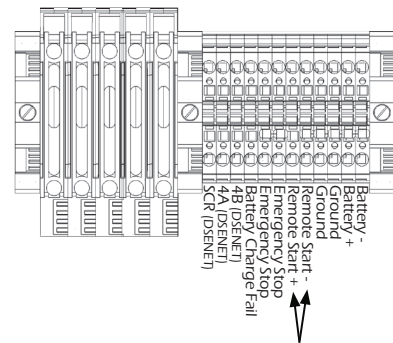

Two-Wire Start Hook-Ups

E STOPS

In some applications additional emergency stops may be desired or necessary. The controller has terminals designed allowing the addition of multiple remote emergency stops. E-stops must be normally closed to work properly in this system. The e-stop circuit supplies power to fuel solenoid and the starter circuit. Opening any switch in the series prevents the engine from cranking or from receiving fuel to run.

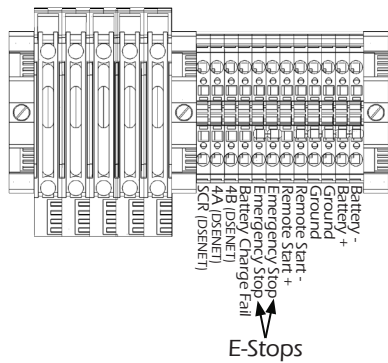

To wire additional emergency stop switches first remove the orange jumper between the two Emergency Stop terminal blocks. Failure to remove the jumper will prevent the remote switches from working properly. Add wires between the terminal block to the new switch(s). The switches must be wired in series for proper function. Test each e-stop after wiring to ensure they function properly.

SERIAL COMMUNICATION

DSE provides a series of remote accessories that can help provide useful information to operators. These accessories communicate over the DSE Net. Terminal blocks are wired to the distribution panel to aid in installation. Follow the instructions included with each accessory.

The generator controller can communicate with a variety of controls and monitoring systems, including RS232 and RS485. The ports are wired onto the back of the DSE7310. In order to finalize communication the program will need to be adjusted using the free DSE configuration software to enable the communication. Contact Winco service for a list of register values.

INSTALLING THE BATTERY

CAUTION

In the following battery installation procedure, check to be sure the engine control is in the “stop” position. This should be your last step before initial start-up.

A customer supplied 12 Volt battery is required to complete the installation. Installation of the highest CCA rated battery, within the correct BCI group, will increase cold weather starting performance.

BATTERY REQUIREMENTS

Model	Voltage	BCI Group	Min. CCA Rating
DE50F4	12	24	650

WARNING: EQUIPMENT DAMAGE

This unit is 12 Volt and is negative ground. Permanent damage will occur if they are connected to a 24 Volt system or a positive ground system. If you are using the truck batteries to start these units, you may have to disable the charging system to keep it from interfering with the vehicle charging system.

Installation and servicing of batteries must only be performed or supervised by personnel knowledgeable of batteries and the required precautions. Keep unauthorized personnel away from batteries.

When installing or replacing batteries, use the proper group/size starting battery. The battery should be a maintenance-free lead acid design. Deep cycle batteries will not work for this application.

CAUTION: PERSONAL DANGER

NEVER dispose a battery in a fire. The battery is capable of exploding. DO NOT open or mutilate the battery. Released electrolyte is known to be harmful to the skin and eyes and to be very toxic.

These engine-generator sets are all NEGATIVE ground. Be very careful not to connect the battery in reverse polarity, as this may short circuit the battery charging system on the engine.

CAUTION

A battery presents a risk of electrical shock and high short circuit current. The following precautions must be observed when working with batteries:

1. Remove watches, rings, and other metal objects.
2. Use tools with insulated handles.
3. Check both the battery cable ends and the battery posts to be sure they are free of corrosion.
4. Always connect the battery positive cable first and then connect the battery negative cable. When removing the battery cables from the battery, reverse the procedure, disconnect the negative first and then the positive cable.
5. Be sure all connections are tight and coat the terminals and cable ends with dielectric grease.

WARNING

The electrolyte is diluted sulfuric acid that is harmful to the skin and eyes. It is electrically conductive and corrosive. The following precautions must always be taken.

1. Always wear full eye protection and protective clothing.
2. Where electrolyte contacts skin, wash off immediately with water.
3. If electrolyte contacts the eyes, flush thoroughly and immediately with water and seek immediate medical attention.
4. Spilled electrolyte is to be washed down with an acid neutralizing agent. A common practice is to use a solution of one pound of bicarbonate of soda (baking soda) to one gallon of water. The bicarbonate of soda solution is to be added until the evidence of reaction (foaming) has ceased. The resulting liquid is to be flushed with water and the area dried.

DANGER: EXPLOSIVE FIRE RISK

1. Never smoke when near batteries.
2. Do not cause a flame or spark in the battery area.
3. Always discharge static electricity from your body before touching batteries by first touching a ground metal surface.

SERVICING BATTERIES

Batteries used on these units may, over time, lose water. This is especially true if you are using a trickle charger to maintain your battery. When refilling the battery with water, use only distilled water. Tap water will shorten the service life of the battery.

Never fill the battery above the fill line. Over filling above the upper level line may cause the electrolyte to overflow, resulting in corrosion to the engine or nearby parts. Immediately wash off any spilled electrolyte following the procedure above.

NOTE: Always make sure that a new battery is fully charged before installing it on a generator set. Failure to do so can cause damage to the engine control module in the generator set.

All connections must be clean and tight. Check the electrolyte in the battery periodically to be sure it is above the plates. Never allow the battery to remain in a discharged condition.

BATTERY CHARGER & BLOCK HEATER

BATTERY CHARGER

A three-stage, on-board marine battery charger is provided standard on this unit. The charger is a 1.5 amp dual use maintainer and charger designed to keep your batteries fully charged by maintaining them automatically.

Make sure all DC battery connections are tight and clean. Follow battery manufacturer's recommendations.

This charger is mounted under the customer connection on the control side of the generator. The charger will need to be plugged to a customer's power source, using a customer supplied heavy duty, UL approved extension cord. The receptacle is to be powered by a GFCI circuit and installed in accordance to the US National Electric Code. It is suggested that this circuit be fused to 20 Amps.

Low/Charge Mode:

The illuminated blue power LED and red low/charging LED. This indicates the Low/Charge mode is in process. When completed the RED Low/Charge LED will turn off.

Auto Maintain Mode:

The illuminated Green auto maintain LED. This indicates your 12volt battery is fully charged. During short or long term storage periods, Auto Maintain (Energy Saver) mode will monitor and auto maintain a battery only when needed to maintain a full state of charge. This feature significantly reduces AC Power consumption, lowers operating costs and maximizes reserve power performance.

BLOCK HEATER

The block heater on this unit is a 1500 watt heater and can use the same 20 Amp GFCI fused circuit. This circuit will terminate on the 120 Volt terminal block mount in the customer connection cabinet. The engine block heater installed on this unit should also be plugged into this receptacle. The block heater is thermostatically controlled when plugged in will maintain the engine coolant temperature between 100 and 120 degrees F.

STARTING PROCEDURE

CAUTION

For the first 10 seconds of operation all of the oil, coolant, and electrical shutdowns are disabled. This is enough time to cause catastrophic damage to the equipment if the pre-start checklist is not properly completed and proper maintenance isn't consistently followed.

CAUTION

The generator set should be given a minimum average load of at least 25% to avoid wet-stacking.

LUBRICATION

Before starting the engine, check the oil level in the crankcase. If it is low, refill to the full mark with the proper weight/grade of oil as recommended by the engine manufacturer's maintenance instructions. The necessity of using the correct oil, and keeping the crankcase full, cannot be over emphasized. Failure to use the proper oil and keep the crankcase properly filled will cause excessive engine wear and shorten its useful life.

WINCO recommends our 5W-40 fully synthetic heavy duty engine oil to give you maximum cold weather protection while maintaining excellent performance in warmer weather. We have partnered with a national lubrication oil manufacturer to give you access to Winco private branded premium oil available at comparable prices to conventional oils. See your dealer for additional information.

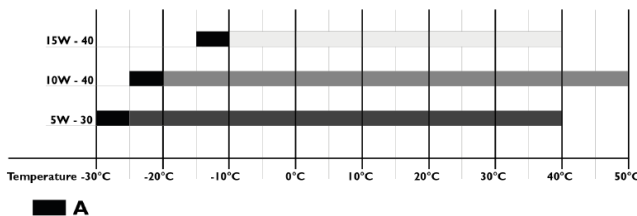

A. Installation of engine coolant heating system with heater on the crankcase is recommended

NOTE: Cold start capabilities are strongly correlated with the quality of the diesel.

Qty of oil	SAE Grade	Base Stock	International specifications	Sulfur Content In The Fuel
WINCO Broad Range	5W-40	Synthetic	API CJ-4 ACEA E6/E9	< 15 ppm
Premium	10W-40	Semi-Synthetic	API CJ-4 ACEA E6/E9	< 15 ppm
Cold Climate	5W-30	Synthetic	API CJ-4 ACEA E6/E9	<15 ppm
Not Authorized	Monograde			

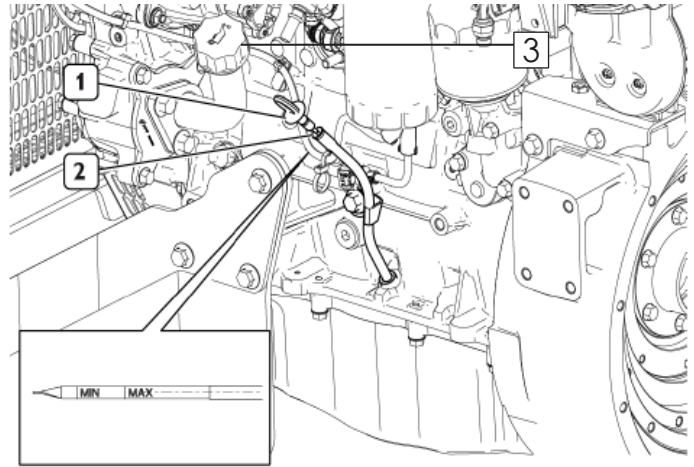

CAUTION: PERSONAL INJURY

Only check oil when the engine is not running and is at a low temperature in order to avoid the risk of burns.

1. Remove the dipstick (1) and ensure the oil level is between the Min and Max limits.
2. If it is difficult to assess the level of the oil, clean the dipstick (1) using a clean cloth and then put it back into its seat (2). Remove the dipstick (1) again and check the level.
3. If level is low, unscrew the plug (3) and refill with suitable oil using the previous table.

COOLANT

Before starting the engine, check the coolant level in the radiator. If it is low, refer to Refilling Coolant in the Maintenance section of this manual. The radiator should be filled to about 1 inch below the filler neck. For additional information on engine coolant requirements, see engine manufacturer's maintenance instructions.

PRE-START CHECK LIST

There is a Pre-Start & Warranty Form that must be filled out by an Authorized WINCO Service Center. After completing the checklist, the engine-generator set is ready for initial start-up.

WARNING: EQUIPMENT DAMAGE

Before attempting to start this unit, complete your pre-start checklist and ensure the generator mainline circuit breaker (if installed) is in the proper position prior to starting. Starting this unit without it properly connected can cause serious personal injury or equipment damage. DO NOT jump start these engine-generator sets. Starting these units on a low battery or jump starting them will cause damage to the engine control module.

MANUAL START PANEL

(Standard)

This generator comes standard with a manual start control panel. The battery is wired to the E-Stop first. The unit will not start if the E-Stop is pushed in (the off position)

There are glow plugs installed and controlled by the engine's ECU. If the coolant temperature falls beneath a set temperature, the engine will automatically engage the glow plugs.

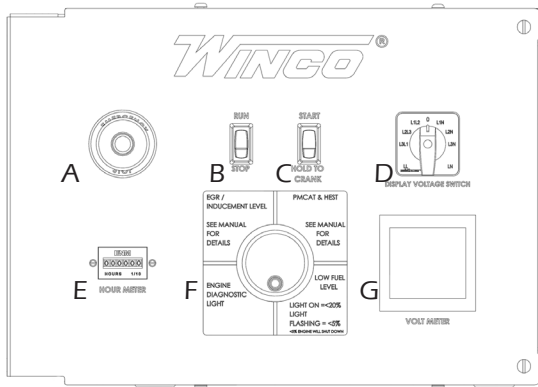

A. E-STOP
 Pushed In - Off
 Pulled Out - On
 The unit will not start if the E-Stop is pushed in the off position.

B. RUN/STOP ROCKER SWITCH
 Run - Engages the engine.
 Stop - Turns unit off.

C. START ROCKER SWITCH
 Start - Hold till engine starts

D. DISPLAY VOLTAGE SWITCH
 Move the switch to the line you want to view on the voltmeter.

E. HOUR METER
 The hour meter will start when the run/stop rocker switch is in the RUN position.

Note: If left in the RUN position for a long period of time, it will time-out after an hour of no use. This will add an hour to the hour meter.

F. WARNING ICON GAUGE

	UPPER LEFT - POSITION #1 EGR (Exhaust Gas Recirculation) Inducement Level
	UPPER RIGHT - POSITION #2 PMCAT & HEST Particulate Matter Catalyst or High Exhaust System Temperature
	LOWER LEFT - POSITION #3 Engine Diagnosis Code
	LOWER RIGHT - POSITION #4 Low Fuel Level

Low fuel lamp will be steady when fuel level has reached 20% or less. It will flash when the fuel level is 5% or less. The engine will shut down if the fuel level is at 5% or less.

In the event that the upper left and upper right icons are flashing, contact your local Service Center for repair.

H. FORCED REGEN BUTTON
 Hold to force a manual regen. The button will have to remained pressed until the regen has completed. **A forced regen should only be performed by a service technician.**

STARTING

Move the rocker switch to the RUN position. The engine lights will light up on the icon gauge. The engine light will still be present until the engine has started. Hold down the START switch until engine starts. Wait five seconds for the engine to reach speed before proceeding.

Note: The ECU may override the start command if the start switch is held for too long.

STOPPING

To turn off the unit, move the rocker switch to STOP.

WARNING: EQUIPMENT DAMAGE

Always make sure the generator runs under no load for five minutes before stopping to allow the engine and components to cool down. Don't use the E-Stop to shut down the generator unless there is an emergency.

RESISTOR

There is a resistor installed inside the harness. If a fuel tank is installed in the field, remove the resistor and connect a one watt fuel sender with a range from 33 to 240 ohms. For units that came assembled with a fuel tank, the resistor can be found in side the panel, loose.





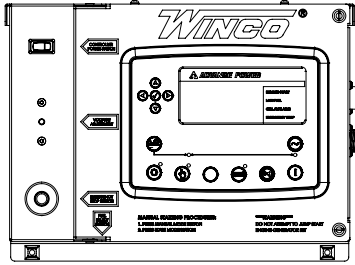

DSE7310 MKII

(Optional)

CAUTION

If the DSE7310 is being replaced with a manual start panel, the voltage on the regulator will need to be adjusted.



	<p>STOP/RESET - This button places the module into its Stop/Reset mode. This will clear any alarm conditions for which the triggering criteria have been removed. The fuel supply de-energizes and the engine comes to a standstill. Should a remote start signal be present while operating in this mode, a remote start WILL NOT occur.</p>
	<p>MANUAL MODE - This button places the module into its Manual Mode. Once in Manual Mode, the model responds to the Start button to start the generator and run it off load.</p>
	<p>START - Pressing this button from STOP/RESET will start the engine and run the load.</p>
	<p>AUTO MODE - This button places the module into its Auto Mode. This mode allows the module to control the function of the generator automatically.</p>
	<p>ALARM/LAMP TEST - This button silences the audible alarm in the controller, deactivates the Audible Alarm output (if configured) and illuminates all of the LEDs on the module's face as a lamp test function.</p>
	<p>MENU NAVIGATION - Used for navigating the instrumentation, event log, and configuration screens.</p>
	<p>A small rocker switch is located on the underside of the engine control cabinet.</p> <p>On gaseous models, the engine timing is controlled by the ECU on the engine and you need to tell it what fuel you want to operate on; LP or NG.</p> <p>On diesel models, this switch has been disconnected and will do nothing.</p>

PROTECTIONS

When an alarm is present, the common alarm LED, if configured, will illuminate. The LCD display will show an icon to indicate the failure.

WARNINGS

Warnings are non-critical alarm conditions. They do not affect the operation of the generator system, they serve to draw the operator's attention to an undesirable condition. Warning alarms are self-resetting when the fault condition is removed. The icon will appear steady in the display.

SHUTDOWN

Shutdowns are critical alarm conditions that stop the engine and draw the operator's attention to an undesirable condition. Shutdown alarms are latching. The fault must be removed and the STOP/RESET button pressed to reset the module. The icon will be flashing in the display.

AUTO MODE

To activate the automatic start mode you will just need to depress the AUTO button, the LED indicator beside the button confirms that the unit is in automatic mode.

To test the Automatic Transfer Switch, follow the instruction on the operator's manual that came with the transfer switch. If you get a fault during the initial start up or prior to start up, it is most likely a false warning light. Simply reset the ATS to start over.

Once you have completed testing of the ATS, be sure you ALWAYS leave the system in the standby mode, unless servicing the unit. For standby operation, press the AUTO button on the front of the control. The green light should light up next to the AUTO button.

NOTE: For setting the exerciser circuit, for all ATS, see the operator's manual shipped with the ATS.

MANUAL MODE

1. Press and release the MANUAL MODE button. The small LED light next to it should come on.

Note: There is no start delay in this mode of operation.

2. Press and release the green START ENGINE button. The DSE 7310 will send two signals to the engine. The first signal wire #21 will engage the fuel solenoid, the second wire, #22, will engage the starter on the engine. At this point the DSE 7310 will start the cranking cycle (10 seconds on and 10 seconds off).

Note: Wire #91 is energized to turn on the glow plugs for 15 seconds first and then the starter and fuel solenoid are engaged.

If the engine fails to start during this cranking period, the starter motor is disengaged and goes into a rest mode after which a second attempt is made to start the engine. Should this sequence continue through 3 cranking cycles the start sequence will be stopped and the display will show 'FAILED TO START'.

3. During manual operation, the load will not normally be applied to the generator. But caution must be used, if the line power should fail or be turned off the transfer switch during manual operation the load may be applied to the generator.

With the engine running smoothly check the no load voltage and frequency on the digital display. The voltage should match the nameplate and a frequency of 59.5 to 60.5 hertz (Hz).

If you have the proper voltage at the generator the next step is to check the voltage at the generator terminals in the Automatic Transfer Switch. The voltage between the G1 and the G3 terminals should be the same as it was on the generator front panel. The voltage should also be checked between the hot terminals (G1 and G3) and the G-N to be certain of a balanced voltage output and a solid neutral connection. The voltage between G1 and G-N should be about 120 volts AC (277 on 480 units). The same approximate voltage should be found between terminals G3 and G-N (120 volts AC).

On three phase panels the G2 voltage level should also be checked. ON 240 VOLT (DELTA) SYSTEMS BE SURE YOU KNOW WHERE THE HIGH VOLTAGE "WILD" LEG IS. IT MUST BE IN THE SAME LOCATION ON THE LINE SIDE AS IT IS ON THE GENERATOR SIDE. (i.e. if it's on L-3 on the line side it must be on G-3 on the generator side. Also on three phase systems make sure that the rotation is the same on the generator as it is on your line power. Failure to insure proper rotation will cause three phase motors to spin backwards possibly damaging them.

NOTICE: If for any reason during the check out procedure the voltage and frequency are not correct, depress the STOP/RESET button and correct the trouble before proceeding.

4. Stopping - There are two ways to stop the unit when it is in the manual mode. Pressing the STOP/RESET button will stop the unit immediately. Pressing the AUTO mode button will stop the unit but only after the cool down timers have timed out and there is no remote start signal being sent to the unit.

WARNING: EQUIPMENT DAMAGE

Always make sure the generator runs under no load for five minutes before stopping to allow the engine and components to cool down. Don't use the E-Stop to shut down the generator unless there is an emergency.

CONTROL POWER

The DSE7310 controller consumes small amounts of battery power when it is in use. The controller comes with a power switch that disconnects battery power when it is not in use. The switch is designed with a safety relay that prevents it from removing power to the controller while the generator is operating. If the switch is turned off while the engine is running it will continue operating until the engine shuts down and then the controller will power down.

This switch should be used when the generator is not going to be used over the course of several days and the generator is not connected to a battery charger.

A solar charger kit is the easiest way to always maintain the battery during storage in mobile applications. The supplied battery charger can be plugged in to an extension cord on mobile applications.

OPERATING CONDITIONS

NORMAL OPERATION

This generator set is designed to be operated under load and the accumulation of operating hours without load can cause unburned fuel from the combustion chamber to build up in the exhaust system. This is called wet stacking and can result in fouled injectors and carbon buildup in the exhaust pipes, turbo and exhaust valves.

The Diesel Oxidation Catalyst (DOC) on the engine has to reach target temperatures during operation for the fuel to burn completely. The generator set should be given a minimum average load of at least 25% to achieve these conditions and avoid damage from wet stacking.

If the engine is cold at start up run it for 2-5 minutes and then load the generator. Idling longer than this is more likely to damage the engine than extend its life

If the generator application is for emergency standby the generator should be exercised at least monthly ideally under load. Load banking the generator at least annually will help keep the engine in good condition.

HARSH ENVIRONMENTS OPERATIONS

Some applications require the generator to operate in harsh environments. One of the most common hazards are extremely dusty conditions. In harsh conditions it is often necessary to take additional steps to keep the equipment clean and operating at its peak. Maintenance intervals on lubricant and filter changes may need to be shortened. An oil quality testing program can also provide early warnings or oil degradation. Efforts may need to be made to reduce the amount of dust and debris entering the housing and generator components.

COLD WEATHER OPERATIONS

The minimum natural starting temperature with glow plugs is -5°F. The minimum starting temperature with glow plugs and block heater is -13°F. The degree of fluidity of the diesel oil can may be reduced at low temperatures due to the separation of the paraffin. This results in the filters becoming clogged. The ASTM D975 or EN590 specifications distinguish different classes of diesel fuel, identifying the characteristics of those that are best adapted to low temperatures.

Oil companies must respect these standards, which provide for the distribution of fuels adapted to the climatic and geographical conditions in various countries.

This generator-engine set needs load and should not idle for long periods of time. If the generator set will be run in extremely cold environments it may be beneficial to provide means to reduce air circulation to increase the temperature of the enclosure. Inspect the CV filters and hoses regularly during cold operation looking for signs of freezing. If the line freezes it will cause pressure to build in the crankcase and may cause an engine seal failure. An optional CV hose heater kit is available to install and is recommended for

units operating in temperatures below 14°F. If the engine operates below optimal temperatures for long periods of time damage may occur.

MAINTENANCE

CHANGING THE OIL

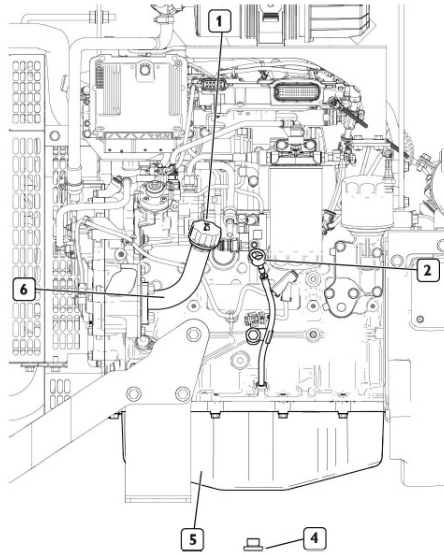

WINCO recommends our 5W-40 fully synthetic heavy duty engine oil to give you maximum cold weather protection while maintaining excellent performance in warmer weather. We have partnered with a national lubrication oil manufacturer to give you access to Winco private branded premium oil available at comparable prices to conventional oils. See your dealer for additional information.

CAUTION: PERSONAL INJURY

Only change oil when the engine is not running and is at a low temperature in order to avoid the risk of burns.

1. Place a drip pan or suitable container for catching the oil below the drain valve attached to the sump (5). WINCO has supplied a valve to hook a customer supplied 5/8" hose to conveniently run the oil to the drip pan.
2. Remove the dip stick (2) and remove the engine lubricant oil filter plug (1).
3. Drain the oil by removing the plug (4) from the oil sump (5).
4. Once the sump (5) has fully drained, close the valve.
5. Top-up through the filler pipe (6) using lubricant oil with the suitable oil table in the LUBRICATION section of this manual..
6. Use the dip stick (2) to ensure the level of oil does not exceed the "MAX" limit.
7. Insert the dipstick and close the lubricant filler cap (1).
8. Dispose of oil in accordance to local codes. DO NOT dispose or allow oil to seep into the ground or sewer systems, doing so will cause environmental damage.

CHANGING OIL FILTER

The filter must be replaced when the lubricant oil is changed.

Only use filters with a filtering degree equal to the original filter.

CAUTION: PERSONAL INJURY

Only change oil when the engine is not running and is at a low temperature in order to avoid the risk of burns.

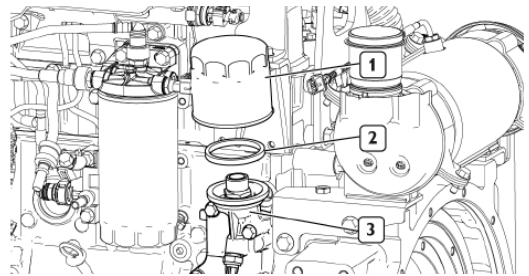

1. Use an oil filter wrench to unscrew and remove the oil filter (1) from the filter mount (3) and recover the gasket (2)
2. Replace the oil filter (1) and gasket (2).
3. Carefully clean the surfaces of the support that are in contact of the gasket (2).
4. Moisten the gasket (2) with a thin layer of oil and place it in its seat on the oil filter (1).
5. Manually tighten the new oil filter on the mount (3) until it is fit up against the gasket (2).
6. Using the oil filter wrench, further tighten the oil filter.

REFILLING COOLANT

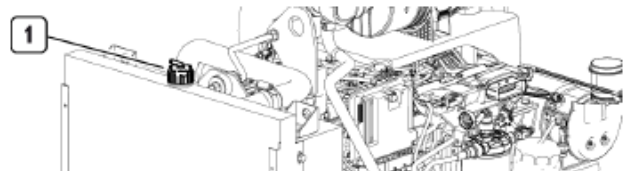

CAUTION: PERSONAL INJURY

Only proceed when the engine is not running and is at a low temperature in order to avoid the risk of burns.

1. Remove the cap (1) on the radiator.
2. With the engine cold, make sure the level of coolant in the radiator is above the minimum level.
3. Refill if necessary.

CHANGING AIR FILTER

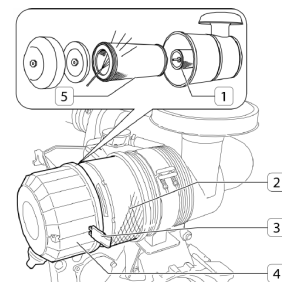

Do NOT remove filter while engine is running.

1. Remove the air filter cover (4) after having released the two quick closing hooks (3).
2. Remove the filter (5). During this operation, take care to ensure that no dust enters the sleeve.

3. Position the filter (5) in its seat.
4. Replace the cover (4) of the air filter and lock it in place using the two quick release hooks (3).

CHECKING WATER IN PRE-FILTER

WARNING: EQUIPMENT DAMAGE

Clean the exhaust valve prior to checking the pre-filter to reduce the risk for system contamination.

Do NOT perform while the engine is running.

1. Place a container for collecting liquids under the pre-filter (2).
2. Unscrew the plug (1) located at the bottom of the filter.
3. Drain the fluid until only fuel comes out.
4. Fully hand-tighten the plug.
5. Dispose of liquid in accordance to local codes. DO NOT dispose or allow liquid to seep into the ground or sewer systems, doing so will cause environmental damage.

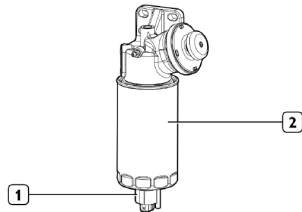

CLEANING RADIATOR

The surfaces of the radiator come into contact with the outside air and can be subject to deposits and impurities. Clean in accordance to the maintenance schedule with compressed air or steam.

REPLACING BLOW-BY FILTER

Do NOT perform while the engine is running.

Using Illustration 1:

1. Remove the belt guard.
2. Unscrew the lower guard screws (2) and remove the lower guard (1).
3. Save the anti-vibration plugs (3).
4. Unscrew the screws (4) and remove the fan guard (5).

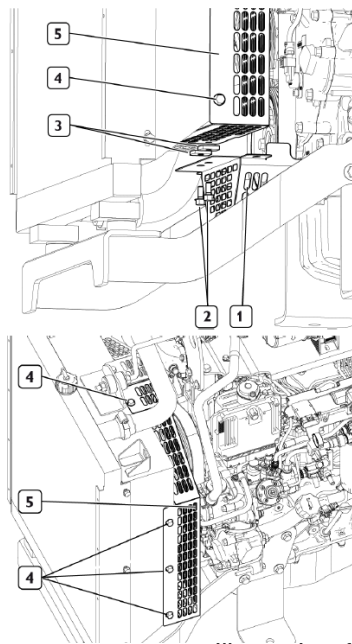

Illustration 1

Using Illustration 2:

1. Loosen the nut (2)
2. Disconnect the fittings (1)(4).
3. Remove the vapor recirculation pipe (3).

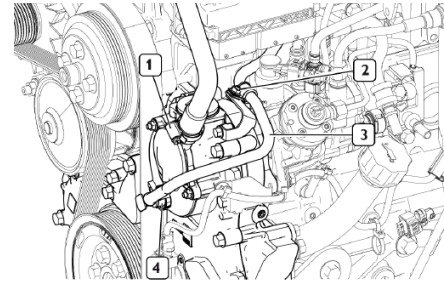

Illustration 2

Using Illustration 3:

1. Unscrew the nuts (6) and remove the cover (5) of the blow-by filter, together with the diaphragm valve and breather pipe.
2. Release the safety circlip (4) and remove the blow-by filter (1) from the threaded bushing (3) and spindle (2).
3. Replace and install the new blow-by filter on the spindle (2) with the threaded bushing (3) and secure with the circlip (4).
4. Fit the cover (5) with the diaphragm valve and breather pipe. Tighten nuts (6).
5. Fit the oil vapor recirculation pipe, connect the relative fittings and screw on the nut.
6. Correctly position the guards inserting the anti-vibration plugs.
7. Secure the other guards.

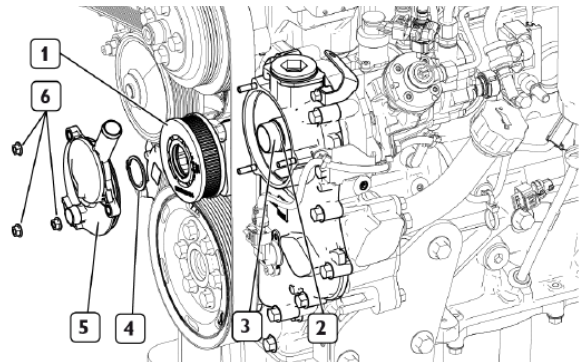

Illustration 3

STORAGE

PREPARING THE ENGINE FOR A LONG PERIOD OF INACTIVITY

In the case of a planned period of inactivity that lasts longer than two months, to prevent the interior parts of the engine and some components of the injection system from oxidizing, prepare the engine as follows:

1. Drain the lubricant oil from the sump after heating the engine.
2. Pour 30/M protective oil into the engine up to the "minimum" level indicated on the oil level dipstick. Start the engine and run it for approx. 5 min.
3. Drain the fuel from the injection circuit, from the filter and from the injection pump channels.

4. Connect the fuel circuit to a tank containing CFB protective liquid (ISO 4113) and introduce the liquid by pressurizing the circuit and driving the engine for approx. 2 min. after excluding injection system operation.

The operation required can be completed by directly polarizing terminal 50 of the electric starter motor with positive voltage equal to that of the nominal system voltage, using the designated conductor.

5. Nebulize the 30/M protective oil in a quantity of approx. 130 g (10 g per liter of displacement) in the turbocharger intake inlet, during the engine turning operation described in the previous paragraph.
6. Close all of the engine's intake, discharge, ventilation and bleeding holes with plugs or seal them with adhesive tape.
7. Drain the residual 30/M protective oil from the sump, which can be used for an additional 2 preparations.
8. Place warning notices of ENGINE WITHOUT OIL on the engine and dashboard.

MAINTENANCE SCHEDULE

Checks In Period of Use	Frequency
Check for water in the fuel Pre-Filter	Daily
Check Air-Restriction Indicator on Filter	Daily
Engine Oil Level	Daily/Prior to Use
Engine Coolant Level	Daily/Prior to Use
Planned Maintenance	Frequency
Tension and Condition Check of Ancillary Belt	600 Hours
Engine Oil Replacement	600 Hours
Oil Filter Replacement	600 Hours
Fuel Pre-Filter Replacement	600 Hours
Fuel Filter Replacement	600 Hours
Clean Radiator	600 Hours
Air Filter Replacement	1200 Hours
Change Blow-By Filter	1800 Hours
Extraordinary Maintenance	Frequency
Ancillary Belt Replacement	3000 Hours
Turbocharger Visual Inspection	1200 Hours
Alternator Visual Inspection	3600 Hours
Clean/Replace Radiator Cap	3600 Hours
Engine Coolant Replacement	3000 Hours

Note: Some operating conditions may require more frequent maintenance intervals.

TROUBLE SHOOTING TABLES

Problem	Possible Causes
Unit will not crank when power fails	Digital genset not in AUTO Transfer control switch not in AUTOMATIC position Incorrect wiring between ATS and genset Defective control relay in ATS Fuse(s) blown in the DSE 7310 Defective DSE 7310 Loose or dirty battery terminals Defective starter Defective start solenoid Low/dead battery
Engine won't crank	Low/dead battery Blown DC fuses Defective DSE 7310 Defective key switch Loose or dirty battery terminals Defective starter Defective start solenoid Locked up engine genset Defective engine harness Improper battery voltage to start solenoid, fuel pump, or fuel solenoid
Engine cranks but will not start	Improper fuel delivery to the unit Fuel supply shut off Fuel tank empty Air in the fuel system Engine fuel solenoid has not opened Defective fuel pump Defective fuel solenoid Defective engine harness Improper battery voltage to fuel pump or fuel solenoid
Engine starts, then stops and alarm light comes on	Engine oil pressure is low Engine has high water temperature Engine has overspeed Engine has gone into overcrank No output from AC generator Loss of speed signal Loss of run signal
Engine will not come up to speed after it starts	Insufficient fuel volume getting to the unit 1. Too small of fuel line 2. Fuel racks not open properly Governor is defective AC short in generator components
ATS will not transfer to Emergency Supply (generator)	No AC generator output Defective ATS control board. See ATS manual Circuit breaker open or defective
ATS will not re-transfer to normal power	Proper power line not available at line terminals in ATS panel Defective ATS control board. See ATS manual
No AC output from generator	Defective diode Defective voltage regulator Defective rotor Defective stator Defective exciter rotor Defective exciter stator AC short in the output leads Defective/open generator output breaker Wiring error

ENGINE CODES

SPN	FMI	Test Translation	DTC
27	3	The electrical Signal of the EGR Valve position sensor is monitored. In case of defect recognition a replacement value is taken.	1B-3
27	4	The electrical Signal of the EGR Valve position sensor is monitored. In case of defect recognition a replacement value is taken.	1B-4
51	3	The electrical Signal of the TVA position sensor is monitored. In case of defect recognition a replacement value is taken.	33-3
51	4	The electrical Signal of the TVA position sensor is monitored. In case of defect recognition a replacement value is taken.	33-4
97	15	The Water in fuel detection is carried out with a digital sensor placed in fuel filter	61-F
100	2	Engine oil pressure value is monitored for plausibility, when engine is stopped, pressure should be lower than a defined maximum value, detected by an oil pressure digital switch. Oil Pressure signal is acquired from oil pressure sensor connected via hardware pin, signal is acquired via digital sensor (DIO)	64-2
100	17	Engine oil pressure value is monitored for plausibility, when engine is running, pressure should be higher than a defined minimum value, detected by an oil pressure digital switch. Oil Pressure signal is acquired from oil pressure sensor connected via hardware pin, signal is acquired via digital sensor (DIO)	64-11
102	3	The electrical Signal of the boost pressure sensor is monitored. In case of defect recognition a replacement value is taken.	66-3
102	4	The electrical Signal of the boost pressure sensor is monitored. In case of defect recognition a replacement value is taken.	66-4
102	20	The plausibility of boost pressure measured under low speed and load conditions is monitored. Boost pressure is compared with environmental pressure.	66-14
102	21	The plausibility of boost pressure measured under low speed and load conditions is monitored. Boost pressure is compared with environmental pressure.	66-15
105	3	The electrical Signal of the air temperature sensor upstream engine Inlet Valve, is monitored. In case of defect recognition a substitute value is taken.	69-3
105	4	The electrical Signal of the air temperature sensor upstream engine Inlet Valve, is monitored. In case of defect recognition a substitute value is taken.	69-4
108	3	Environmental pressure sensor is available and connected via hardware to the ECM. Pressure is obtained through Analogic to Digital Converter and transformed to a physical value in EnvP_pSens. A signal range check is performed on the signal. Sensor is inside ECU.	6C-3
108	4	Environmental pressure sensor is available and connected via hardware to the ECM. Pressure is obtained through Analogic to Digital Converter and transformed to a physical value in EnvP_pSens. A signal range check is performed on the signal. Sensor is inside ECU."	6C-4
110	3	Electrical Signal range check of Coolant temperature sensor	6E-3
110	4	Electrical Signal range check of Coolant temperature sensor Coolant temperature voltage below or shorted to low source	6E-4
110	15	Two engine temperature thresholds are available to signal high engine temperature. Pre-warning is set if engine temperature > 101,96°C Warning is set if engine temperature > 105,96°C	6E-F
110	16	Two engine temperature thresholds are available to signal high engine temperature. Pre-warning is set if engine temperature > 101,96°C Warning is set if engine temperature > 105,96°C"	6E-10
152	2	A software internal failure occurred which lead to a software reset. This reset caused a failure which is only visible for manufacturer specific testers.	98-2
157	0	This function is used for monitoring the rail pressure when the rail control loop is in limp home mode operated with a PRV.	9D-0
157	2	The Fuel Rail pressure control is executed with a device: Metering Unit (MeUn) as feeding quantity control and an overpressure valve allocate in the rail (PRV).The desired fuel quantity to reach the requested rail pressure is higher than expected at idle speed, a leaky system must be assumed.	9D-2
157	3	Electric monitoring of Fuel Rail Pressure sensor	9D-3
157	4	Electric monitoring of Fuel Rail Pressure sensor	9D-4
157	10	A loose contact in the rail pressure sensor wiring can lead to incorrect measuring of the rail pressure. If this does occur, typically the measured pressure rises considerably for a brief time (jumps > 500,00bar in a 10 ms window). This kind of extreme pressure increase does not occur in the system. To determine a malfunction based on this appearance, gradient monitoring of the rail pressure is performed.	9D-A
157	16	The Fuel Rail pressure control is executed with a device: Metering Unit (MeUn) as feeding quantity control and an overpressure valve allocate in the rail (PRV). The Fuel Rail pressure control is executed via Metering Unit (MeUn) as feeding quantity control and pressure sensor. The Fuel Rail pressure control is executed with a device: Metering Unit (MeUn) as feeding quantity control and an overpressure valve allocate in the rail (PRV). High pressure system leakage is checked at overrun.	9D-10
157	17	The minimum rail pressure value necessary to allow fuel injection is monitored.	9D-11

SPN	FMI	Test Translation	DTC
157	18	The Fuel Rail pressure control is executed with a device: Metering Unit (MeUn) as feeding quantity control and an overpressure valve allocate in the rail (PRV).	9D-12
166	2	Dataset Interlock Feature is used to prevent the flashing of unintended datasets on to the ECU during any SW upgrades in field. This fault path is used to indicate if there was an error during a Write/Read EEPROM operation.	A6-2
166	14	Dataset Interlock Feature is used to prevent the flashing of unintended datasets on to the ECU during any SW upgrades in field. This fault path is used to indicate if there was an error during a Write/Read EEPROM operation.	A6-E
168	3	Static monitoring (signal range check) of the battery voltage.	A8-3
168	4	Static monitoring (signal range check) of the battery voltage.	A8-4
172	3	Environmental temperature sensor is available and connected via hardware to the ECM. Temperature is obtained through Analogic to Digital Converter and transformed to a physical value in EnvT_tSens. A signal range check is performed on the signal.	AC-3
172	4	Environmental temperature sensor is available and connected via hardware to the ECM. Temperature is obtained through Analogic to Digital Converter and transformed to a physical value in EnvT_tSens. A signal range check is performed on the signal.	AC-4
174	3	The electrical Signal of the Fuel temperature sensor is monitored. In case of defect recognition a default value for the fuel temperature is taken. In case of defect a fix value or the actual engine temperature can be taken as substitution, depending on configuration (by data set) and reliability of the sensors.	AE-3
174	4	The electrical Signal of the Fuel temperature sensor is monitored. In case of defect recognition a default value for the fuel temperature is taken. In case of defect a fix value or the actual engine temperature can be taken as substitution, depending on configuration (by data set) and reliability of the sensors.	AE-4
190	8	The Engine Position Management module is responsible for signals from camshaft and crankshaft sensor evaluation: angle and speed determination, signal plausibility and quality are monitored by this module. Presence of crankshaft speed signal is monitored here.	BE-8
190	15	Engine speed is monitored and in case of overspeed detection a failure is reported. Unacceptably high engine speed may arise in the event of an error in the ECM or under certain operating states like downhill travel, in this case the failure should does not indicate an error but simply informs about a "misuse" of the engine.	BE-F
593	31	Assuming the condition to enable the engine shut off then the engine will shut down after a countdown timer. The status signal indicates when the countdown timer has elapsed (CoEng_stdIshDwnStM_mp=3). The monitor is triggered by Fid_CoEngIdleShDwnLvl2.	251-1F
594	31	The engine coordinator stop function provides the system with the status for engine shut off, low idle and crank control depending on the various input conditions of engine speed, vehicle speed, vehicle speed sensor defect, engine start status, parking brake switch status and stop switch input. For the idle shut down a state machine is used. The state in which the state machine is at the moment is shown in the message CoEng_stdIshDwnStM_mp. Assuming the conditions to enable the engine shut off then the engine will shut down after a countdown timer. The status signal indicates when the countdown timer is below a timer calibrated (CoEng_stdIshDwnStM_mp=1)."	252-1F
623	6	The Power stage of Stop Lamp is monitored by Hardware for electric failures.	26F-6
624	6	The Power stage of Warning Lamp is monitored by Hardware for electric failures.	270-6
630	2	The injectors are corrected individually (IMA Code) to guarantee exact fuel injection quantity of each injector from lowest to highest fuel quantity. The correction is done at the end of production line (EOL) and after substitution of the injectors with the tester. The data's are stored in the EEPROM. The stored values in the EEPROM are protected with checksum parameters. At each Key 15 "on" the correction data's are read from the EEPROM and checked, if the values are plausible and the checksums are correct. If not, the injector will not be corrected and a failure will be stored.	276-2
637	11	The Engine Position Management module is responsible for signals from camshaft and crankshaft sensor evaluation: angle and speed determination, signal plausibility and quality are monitored by this module. Plausibility between camshaft and crankshaft speed sensor signal is monitored here.	27D-B
639	9	The message TSC1VE contains the information for torque/speed demand from Vehicle Controller to EDC. TSC1 CAN messages (Torque/Speed Control) are sent at fast rate if Torque/speed request is active and at slower rate if no request is active, to reduce CAN traffic, so different timeout monitor are provided: a fast one if a request is active (active timeout), and a slow one if no request is active (passive timeout).	27F-9
651	5	Hardware errors in the injectors and respective ECM power stages are investigated. Diagnostic procedure uses pattern detection to identify specific errors and trigger appropriate substitute reaction. The behavior pattern describes in a bit mask different detected problem (overcurrent, command collision, RAM error,short circuit,...) when the expected combination of errors is detected (measured and reference pattern are matching) a failure is detected.	28B-5
651	6	Hardware errors in the injectors and respective ECM power stages are investigated. Diagnostic procedure uses pattern detection to identify specific errors and trigger appropriate substitute reaction. The behavior pattern describes in a bit mask different detected problem (overcurrent, command collision, RAM error,short circuit,...) when the expected combination of errors is detected (measured and reference pattern are matching) a failure is detected.	28B-6
651	20	ZFL functionality (Zero Fuel Calibration during Low Idle) evaluates energizing time for injectors at low idle. The ZFL is changing the energizing time of the pilot injection by adding the learned calibration values. A monitoring of these learn values is required.	28B-14
651	21	ZFL functionality (Zero Fuel Calibration during Low Idle) evaluates energizing time for injectors at low idle. The ZFL is changing the energizing time of the pilot injection by adding the learned calibration values. A monitoring of these learn values is required.	28B-15

SPN	FMI	Test Translation	DTC
652	5	Hardware errors in the injectors and respective ECM power stages are investigated. Diagnostic procedure uses pattern detection to identify specific errors and trigger appropriate substitute reaction. The behavior pattern describes in a bit mask different detected problem (overcurrent, command collision, RAM error,short circuit,...) when the expected combination of errors is detected (measured and reference pattern are matching) a failure is detected.	28C-5
652	6	Hardware errors in the injectors and respective ECM power stages are investigated. Diagnostic procedure uses pattern detection to identify specific errors and trigger appropriate substitute reaction. The behavior pattern describes in a bit mask different detected problem (overcurrent, command collision, RAM error,short circuit,...) when the expected combination of errors is detected (measured and reference pattern are matching) a failure is detected.	28C-6
652	20	ZFL functionality (Zero Fuel Calibration during Low Idle) evaluates energizing time for injectors at low idle. The ZFL is changing the energizing time of the pilot injection by adding the learned calibration values. A monitoring of these learn values is required.	28C-14
652	21	ZFL functionality (Zero Fuel Calibration during Low Idle) evaluates energizing time for injectors at low idle. The ZFL is changing the energizing time of the pilot injection by adding the learned calibration values. A monitoring of these learn values is required.	28C-15
653	5	Hardware errors in the injectors and respective ECM power stages are investigated. Diagnostic procedure uses pattern detection to identify specific errors and trigger appropriate substitute reaction. The behavior pattern describes in a bit mask different detected problem (overcurrent, command collision, RAM error,short circuit,...) when the expected combination of errors is detected (measured and reference pattern are matching) a failure is detected.	28D-5
653	6	Hardware errors in the injectors and respective ECM power stages are investigated. Diagnostic procedure uses pattern detection to identify specific errors and trigger appropriate substitute reaction. The behavior pattern describes in a bit mask different detected problem (overcurrent, command collision, RAM error,short circuit,...) when the expected combination of errors is detected (measured and reference pattern are matching) a failure is detected.	28D-6
653	20	ZFL functionality (Zero Fuel Calibration during Low Idle) evaluates energizing time for injectors at low idle. The ZFL is changing the energizing time of the pilot injection by adding the learned calibration values. A monitoring of these learn values is required.	28D-14
653	21	ZFL functionality (Zero Fuel Calibration during Low Idle) evaluates energizing time for injectors at low idle. The ZFL is changing the energizing time of the pilot injection by adding the learned calibration values. A monitoring of these learn values is required.	28D-15
654	5	Hardware errors in the injectors and respective ECM power stages are investigated. Diagnostic procedure uses pattern detection to identify specific errors and trigger appropriate substitute reaction. The behavior pattern describes in a bit mask different detected problem (overcurrent, command collision, RAM error,short circuit,...) when the expected combination of errors is detected (measured and reference pattern are matching) a failure is detected.	28E-5
654	6	Hardware errors in the injectors and respective ECM power stages are investigated. Diagnostic procedure uses pattern detection to identify specific errors and trigger appropriate substitute reaction. The behavior pattern describes in a bit mask different detected problem (overcurrent, command collision, RAM error,short circuit,...) when the expected combination of errors is detected (measured and reference pattern are matching) a failure is detected.	28E-6
654	20	ZFL functionality (Zero Fuel Calibration during Low Idle) evaluates energizing time for injectors at low idle. The ZFL is changing the energizing time of the pilot injection by adding the learned calibration values. A monitoring of these learn values is required.	28E-14
654	21	ZFL functionality (Zero Fuel Calibration during Low Idle) evaluates energizing time for injectors at low idle. The ZFL is changing the energizing time of the pilot injection by adding the learned calibration values. A monitoring of these learn values is required.	28E-15
676	5	The Power stage of glow plug is monitored by hardware for electric failures. In case of a relay between ECU and Glow plug, the failure can be caused by the relay and not by the glow plug. If there is no intelligent relay, real electric failure of glow plug can not be detected. This monitor is used for Glow Plug of Low Voltage System (GCU-T), not used for FUSO applications The Power stage of glow plug is monitored by Hardware for electric failures. In case of a relay between ECU and Glow plug, the failure can be caused by the relay and not by the glow plug. If there is no intelligent relay, real electric failure of glow plug can not be detected.	2A4-5
676	6	The Power stage of glow plug is monitored by Hardware for electric failures. In case of a relay between ECU and Glow plug, the failure can be caused by the relay and not by the glow plug. If there is no intelligent relay, real electric failure of glow plug can not be detected. This monitor is used for Glow Plug of Low Voltage System (GCU-T), not used for FUSO applications The Power stage of glow plug is monitored by Hardware for electric failures. In case of a relay between ECU and Glow plug, the failure can be caused by the relay and not by the glow plug. If there is no intelligent relay, real electric failure of glow plug can not be detected.	2A4-6
676	19	The Power stage of glow plug is monitored by Hardware for electric failures. In case of a relay between ECU and Glow plug, the failure can be caused by the relay and not by the glow plug. If there is no intelligent relay, real electric failure of glow plug can not be detected. This monitor is used for Glow Plug of Low Voltage System (GCU-T), not used for FUSO applications	2A4-13
677	3	Engine Starter is controlled by two relays actuators one for Low Side and one for High Side. Both power stages are monitored by Hardware for electric failures.	2A5-3
677	5	Engine Starter is controlled by two relays actuators one for Low Side and one for High Side. Both power stages are monitored by Hardware for electric failures.	2A5-5

SPN	FMI	Test Translation	DTC
677	6	Engine Starter is controlled by two relays actuators one for Low Side and one for High Side. Both power stages are monitored by Hardware for electric failures.	2A4-6
723	8	The Engine Position Management module is responsible for signals from camshaft and crankshaft sensor evaluation: angle and speed determination, signal plausibility and quality are monitored by this module. Plausibility of number and position of the camshaft edges detected by camshaft speed sensor is monitored here.	2D3-8
977	12	The post drive control, controls the system state which is activated by switching key15 off. Test and management tasks are carried out here. Shut off time of CY320 (power stage supplier) is monitored.	3D1-C
1076	2	A loose contact in the wiring of the metering unit can result in a malfunction of the metering unit and lead to fuel pressure oscillations (irregular engine running, possible Fuel pressure failures detected). A permanent loosen contact is detected by the electrical monitoring (SCB,SCG,OL Monitorings), but very short contact loosing (e.g. due to vibration) are not detected. Therefore this monitoring counts the number "short term loosen contacts" (shorter than debouncing of electrical failure) in the way, that a counter is incremented by one each time a loosen contact is recognized, and decremented by 1, if the time between 2 loosen contact recognitions is longer than 3,00s. If the counter reaches or exceeds 1000,00- a "bad contact" will be recognized.	434-2
1076	5	The power stage of the fuel metering unit to common rail (MeUn) is monitored electrically for voltage and current by hardware. The Power stage of Metering Unit at Low Side is monitored by Hardware for electric failures.	434-5
1076	6	The power stage of the fuel metering unit to common rail (MeUn) is monitored electrically for voltage and current by hardware. The Power stage of Metering Unit at Low Side is monitored by Hardware for electric failures.	434-6
1081	5	The Power stage for the control lamp for Glow Plug activation is controlled by Hardware for electrical failures	439-5
1081	6	The Power stage for the control lamp for Glow Plug activation is controlled by Hardware for electrical failures	439-6
1127	16	Boost pressure value is monitored, if actual boost pressure is higher than target boost pressure beside a defined threshold a failure is detected.	467-10
1127	18	Pressure Charger Regulator is monitored for any deviation of actual boost pressure from target pressure. Underboost is detected if the engine is running within the specified working area and a positive boost pressure deviation is detected.	467-12
1188	5	The Power stage of Bitron actuator is monitored by Hardware for electric failures.	4A4-5
1188	6	The Power stage of VGT actuator is monitored by Hardware for electric failures. The Power stage of Bitron actuator is monitored by Hardware for electric failures.	4A4-6
1209	3	The turbine upstream pressure is acquired via hardware connected sensor. The raw voltage signal is acquired in the message Exh_uRawPTrbnUs. This signal is checked for the Signal Range Errors and then transformed into physical value Exh_pSensPTrbnUs.	4B9-3
1209	4	The turbine upstream pressure is acquired via hardware connected sensor. The raw voltage signal is acquired in the message Exh_uRawPTrbnUs. This signal is checked for the Signal Range Errors and then transformed into physical value Exh_pSensPTrbnUs.	4B9-4
1221	2	Communication between ECM processor and power stage controller over SPI bus is monitored. Error is detected if no response or an erroneous response is detected by the processor.	4C5-2
1239	0	The Fuel Rail pressure control is executed with a device: Metering Unit (MeUn) as feeding quantity control and an overpressure valve allocate in the rail (PRV). The desired fuel flow is adjusted by feed back control for reaching the desired fuel pressure. If this needed fuel flow exceeds a maximal expected fuel flow by more than a fuel flow dependent value (15700,00mm3/s at 4500,00mm3/s to 14000,00mm3/s at 14330,00mm3/s), leakage in the system must be assumed.	4D7-0
1485	7	"The Main relay is controlled by the ECU itself: After Key 15 off the ECU goes into the ""After-run"", where mainly following actions are made: - storage of the failures into the memory - counting of driving cycles and the corresponding reactions (pending -> validated failure, failure declared as long time failure etc.) Therefore the Main Relay is controlled by the ECU to assure the After-run. The main Relay is switched off by the ECU itself after the After-run has finished. After the request of "Main Relay switch off" the ECU expects, that the supply voltage drops below limit within 500,00ms. If not, it is assumed that the main relay is stuck in closed position.	5CD-7
1485	14	The Main relay is controlled by the ECU itself: After Key 15 off the ECU goes into the ""After-run"", where mainly following actions are made: - storage of the failures into the memory - counting of driving cycles and the corresponding reactions (pending -> validated failure, failure declared as long time failure etc.) Therefore the Main Relay is controlled by the ECU to assure the After-run. The main Relay is switched off by the ECU itself after the After-run has finished. This means, that all this actions can not be done, if the Main relay switches off before the After-run has finished. Therefore the correct opening of Main Relay is monitored. At each start a bit in the EEPROM is set, which is reset to 0 at the end of the After-run immediately before the ECU switches off the Main Relay. At next start the System checks the state of the bit in the EEPROM: If it is still set, this means that the Main Relay was switched off before the request of the ECU.	5CD-E
2791	5	The Power stage of electric EGR Valve actuator (H-Bridge) is monitored by Hardware for electric failures. The Power stage of electric EGR Valve actuator (H-Bridge) is monitored by Hardware for electric failures. The H-Bridge has 2 switches (High side and Low side). Each circuit is monitored separately. The Power stage of electric EGR Valve actuator (H-Bridge) is monitored by Hardware for electric failures.	AE7-5

SPN	FMI	Test Translation	DTC
2791	6	The Power stage of EGR Valve actuator is monitored by Hardware for electric failures. The Power stage of electric EGR Valve actuator (H-Bridge) is monitored by Hardware for electric failures. The H-Bridge has 2 switches (High side and Low side). Each circuit is monitored separately. The Power stage of electric EGR Valve actuator (H-Bridge) is monitored by Hardware for electric failures. An overload error is not detectable directly in case the wiring length is > 1m and the failure occurs near the actuator. Therefore a plausibility check is made in case a failure "Short circuit to Battery" (SCB) or "Short circuit to Ground" (SCG) is detected. Therefore the switch (Low side in case of SCB, High side in case of SCG) is closed. If the Short Circuit failure disappears, it is cleared and the Overload failure activated.	AE7-6
2791	7	The EGR Valve actuator gives a feedback with a position sensor. If there is a positive deviation between required and measured position, the failure is activated. The system tries then to "unblock" the actuator closing or opening it fast. If it is not possible to "unblock" the actuator, the failure "Jammed Valve" is activated.	AE7-7
2797	6	Hardware errors in the injectors and respective ECM power stages are investigated. Diagnostic procedure uses pattern detection to identify specific errors and trigger appropriate substitute reaction. The behavior pattern describes in a bit mask different detected problem (over current, command collision, RAM error,short circuit,...) when the expected combination of errors is detected (measured and reference pattern are matching) a failure is detected. Two banks are present.	AED-6
2797	7	Hardware errors in the injectors and respective ECM power stages are investigated. Diagnostic procedure uses pattern detection to identify specific errors and trigger appropriate substitute reaction. The behavior pattern describes in a bit mask different detected problem (overcurrent, command collision, RAM error,short circuit,...) when the expected combination of errors is detected (measured and reference pattern are matching) a failure is detected.	AED-7
2798	6	Hardware errors in the injectors and respective ECM power stages are investigated. Diagnostic procedure uses pattern detection to identify specific errors and trigger appropriate substitute reaction. The behavior pattern describes in a bit mask different detected problem (over current, command collision, RAM error,short circuit,...) when the expected combination of errors is detected (measured and reference pattern are matching) a failure is detected. Two banks are present.	AEE-6
2840	12	The hardware encapsulation of CY320 performs a diagnostic of the sensor supplies and monitors the communication Between processor and voltage supply device CY320. A functionality for reading writing and erasing values to a memory media (Flash or EEPROM) is available. These operations are monitored and if problems arise a failure is reported. Communication between CJ945 (power stage chips) and CY320 (power stage voltage supplier) is monitored. The HWE-module R2S2 is the LowLevel Chipdriver for the Powerstage-Chips R2S25200kfp. The R2S25200 is a chip with 18 powerstages and an additional module for the monitoring of the ECU internal 5V Supply-Voltage. It is possible to configure max. 4 R2S2.	B18-C
2840	14	Calibrated parameters for baud rate cannot be read from EEPROM	B18-E
2880	2	A range and plausibility check for the value of PTO switch are performed. The source for the multi value PTO switch is an analogic input.	B40-2
2880	3	A range and plausibility check for the value of PTO switch are performed. The source for the multi value PTO switch is an analogic input.	B40-3
2880	4	A range and plausibility check for the value of PTO switch are performed. The source for the multi value PTO switch is an analogic input.	B40-4
3242	0	Physical signal range check: Exhaust Temperature before EGR exit can not exceed physically 799,96°C. If the measured value is higher, the sensor signal is not reliable.	CAA-0
3242	3	The electrical Signal of the Particle Filter temperature upstream sensor is monitored. In case of defect recognition a substitute value is taken.	CAA-3
3242	4	The electrical Signal of the Particle Filter temperature upstream sensor is monitored. In case of defect recognition a substitute value is taken.	CAA-4
3358	10	The system evaluates the main physical parameters of engine (intake temperature and pressure, lambda, EGR position, temperature and pressure in exhaust path) in order to discover a leakage on path from compressor downstream and intake path.	D1E-A
3509	2	The hardware encapsulation of CY320 performs a diagnostic of the sensor supplies and monitors the communication Between processor and voltage supply device CY320. For reasons of safety the ECM provides 3 independent 5V voltage supplies for the sensors. These sensor supply voltages are monitored to ensure they remain within a given range. This check for voltage limits is done autonomously by the hardware (thresholds not applicable).	DB5-2
3510	2	The hardware encapsulation of CY320 performs a diagnostic of the sensor supplies and monitors the communication Between processor and voltage supply device CY320.For reasons of safety the ECM provides 3 independent 5V voltage supplies for the sensors. These sensor supply voltages are monitored to ensure they remain within a given range. This check for voltage limits is done autonomously by the hardware (thresholds not applicable).	DB6-2
3511	2	The hardware encapsulation of CY320 performs a diagnostic of the sensor supplies and monitors the communication Between processor and voltage supply device CY320. For reasons of safety the ECM provides 3 independent 5V voltage supplies for the sensors. These sensor supply voltages are monitored to ensure they remain within a given range. This check for voltage limits is done autonomously by the hardware (thresholds not applicable).	DB7-2
3719	0	When filter regeneration is insufficient, due too prolonged city driving cycle (low exhaust temperatures) or DOC is damaged (no feed gas produced), filter flow resistance can increase above critical values.	E87-0
3719	16	When filter regeneration is insufficient, due too prolonged city driving cycle (low exhaust temperatures) or DOC is damaged (no feed gas produced), filter flow resistance can increase above critical values.	E87-10

SPN	FMI	Test Translation	DTC
4009	5	The Power stage of Fuel Filter heater is monitored by Hardware for electric failures.	FA9-5
4009	6	The Power stage of Fuel Filter heater is monitored by Hardware for electric failures.	FA9-6
4765	3	The electrical Signal of the Oxi Cat temperature upstream sensor is monitored. In case of defect recognition a substitute value is taken.	129D-3
4765	4	The electrical Signal of the Oxi Cat temperature upstream sensor is monitored. In case of defect recognition a substitute value is taken.	129D-4
5319	31	Duration of regeneration is monitored. If maximum defined time is exceeded failure is detected	14C7-1F
5324	7	The Power stage of glow plug is monitored by Hardware for electric failures. In case of a relay between ECU and Glow plug, the failure can be caused by the relay and not by the glow plug. If there is no intelligent relay, real electric failure of glow plug can not be detected. In the system are present a low voltage system (metal or ceramic glow plug).	14CC-7
5325	7	The Power stage of glow plug is monitored by Hardware for electric failures. In case of a relay between ECU and Glow plug, the failure can be caused by the relay and not by the glow plug. If there is no intelligent relay, real electric failure of glow plug can not be detected. In the system are present a low voltage system (metal or ceramic glow plug).	14CD-7
5326	7	The Power stage of glow plug is monitored by Hardware for electric failures. In case of a relay between ECU and Glow plug, the failure can be caused by the relay and not by the glow plug. If there is no intelligent relay, real electric failure of glow plug can not be detected. In the system are present a low voltage system (metal or ceramic glow plug).	14CE-7
5327	7	The Power stage of glow plug is monitored by Hardware for electric failures. In case of a relay between ECU and Glow plug, the failure can be caused by the relay and not by the glow plug. If there is no intelligent relay, real electric failure of glow plug can not be detected. In the system are present a low voltage system (metal or ceramic glow plug).	14CF-7
5419	5	The Power stage of electric Throttle Valve actuator (H-Bridge) is monitored by Hardware for electric failures. The Power stage of electric Throttle Valve actuator (H-Bridge) is monitored by Hardware for electric failures. The H-Bridge has 2 switches (High side and Low side). Each circuit is monitored separately. The Power stage of electric Throttle Valve actuator (H-Bridge) is monitored by Hardware for electric failures.	152B-5
5419	6	The Power stage of Throttle Valve actuator is monitored by Hardware for electric failures. The Power stage of electric Throttle Valve actuator (H-Bridge) is monitored by Hardware for electric failures. The H-Bridge has 2 switches (High side and Low side). Each circuit is monitored separately. A plausibility check is made in case a failure "Short circuit to Battery" (SCB) or "Short circuit to Ground" (SCG) is detected. Therefore the switch (Low side in case of SCB, High side in case of SCG) is closed. If the Short Circuit failure disappears, it is cleared and the Overload failure activated.	152B-6
5419	7	The Throttle Valve actuator gives a feedback with a position sensor. If there is a deviation between required and measured position, the failure is activated. The system tries then to "unblock" the actuator closing or opening it fast. If it is not possible to "unblock" the actuator, the failure "Jammed Valve" is activated.	152B-7
5571	10	"To determine mechanical wearout, the Pressure Relief Valve can be forced to open by performing a defined rail pressure shock in two steps: - Waiting for rail pressure build up - Performing pressure shock The two steps are recorded in the failure memory. Pressure shock is only possible in a defined engine speed/injection quantity range."	15C3-E
5571	14	For determination of the mechanical state of the pressure relief valve it is detected, if the pressure relief valve is forced to open too many times. The monitoring of the wear out of the PRV is done by counting the number of times the PRV is opened and the duration of its opening. The duration of opening (PRV_tiOpn_mp) is accumulated in every driving cycle and stored in the EEPROM in after run state of the engine. If the PRV was open for a longer time than the applied limit a failure is detected.	15C3-E
5571	16	If rail pressure exceeds normal operation values a mechanical valve (PRV= pressure Relief Valve) is opened to control maximum rail pressure	15C3-10
5571	2	PRV is classified as open after the successful evaluation of the rail pressure gradients After this the rail pressure averaging is executed continuously. If the average rail pressure is outside the expected range the open evaluation of the pressure relief valve by rail pressure averaging failed	15C3-2
5571	7	To determine mechanical wearout, the Pressure Relief Valve can be forced to open by performing a defined rail pressure shock in two steps: - Waiting for rail pressure build up - Performing pressure shock The two steps are recorded in the failure memory. Pressure shock is only possible in a defined engine speed/injection quantity range.	15C3-7
5826	16	Euro VI and US2010 legislations require special measures to induce proper functionality of SCR and EGR systems in Heavy Duty engines. SCR and EGR system related faults are monitored and trigger different warning and reaction. The inducements start with a driver warning, then a torque reduction follows and if the fault is not fixed, a creep mode with strongly reduced maximal vehicle speed is activated. Failures which trigger inducements are grouped in 5 different categories: - EGR Valve Blocked - Interruption of Dosing - Reagent Consumption - Reagent Quality - Tampering The inducement logic is applied also a DPF to avoid its irreversible damage or its tampering.	16C2-10

WIRING SIZE TABLE

The table below is based on Table 310.15 (B) (16) in the National Electric Code 2014 edition. Allowable ampacities of insulated conductors rated 0 through 2000V, 75°C through 90°C. Not more than three current-carrying conductors in Raceway, Cable, or Earth (direct buried). Adjust for 40°C (104°F) ambient temperature.

Copper 75°C	Copper 90°C		Aluminum Copper Clad Aluminum 75°C	Aluminum Copper Clad Aluminum 90°
Wire Type: RHW, THHW, THW, THWN, XHHW, USE, ZW	Wire Type: TBS, SA, SIS, FEP, FEPB, MI, RHH, RHW-2, THHN, THHW, THW-2, XHH, XHHW, XHHW- 2, ZW-2	SIZE AWG OR KCMIL	Wire Type: RHW, THHW, THW, THWN, XHHW, USE	Wire Type: TBS, SA, SIS, THHN, THW-2, THWN-2, RHH, RHW-2, USE-2, XHH, XHHW, XHHW-2, ZW-2
50	55	8	40	45
65	75	6	50	55
85	95	4	65	75
100	115	3	75	85
115	130	2	90	100
130	145	1	100	115
150	170	1/0	120	135
175	195	2/0	135	150
200	225	3/0	155	175
230	260	4/0	180	205
255	290	250	205	230
285	320	300	230	260
310	350	350	250	280
335	380	400	270	305
380	430	500	310	350
420	475	600	340	385
460	520	700	375	425
475	535	750	385	435
490	555	800	395	445
520	585	900	425	480
545	615	1000	445	500
590	665	1250	485	545
625	705	1500	520	585
650	735	1750	545	615
655	750	2000	560	630

For additional information, see table 310.15 of the National Electric Code.

ENGINE HARNESS

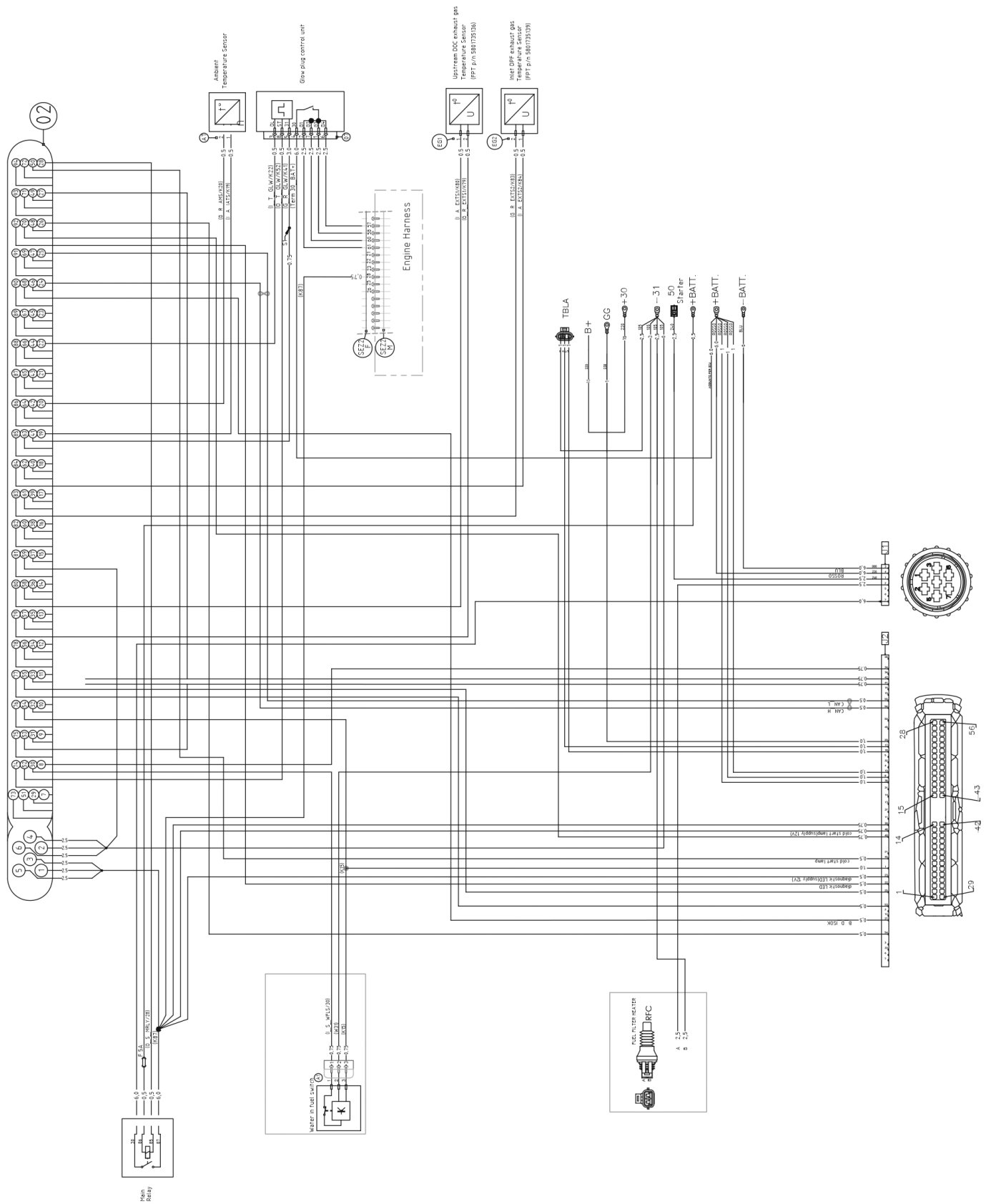

CONTROL PANEL WIRING DIAGRAM

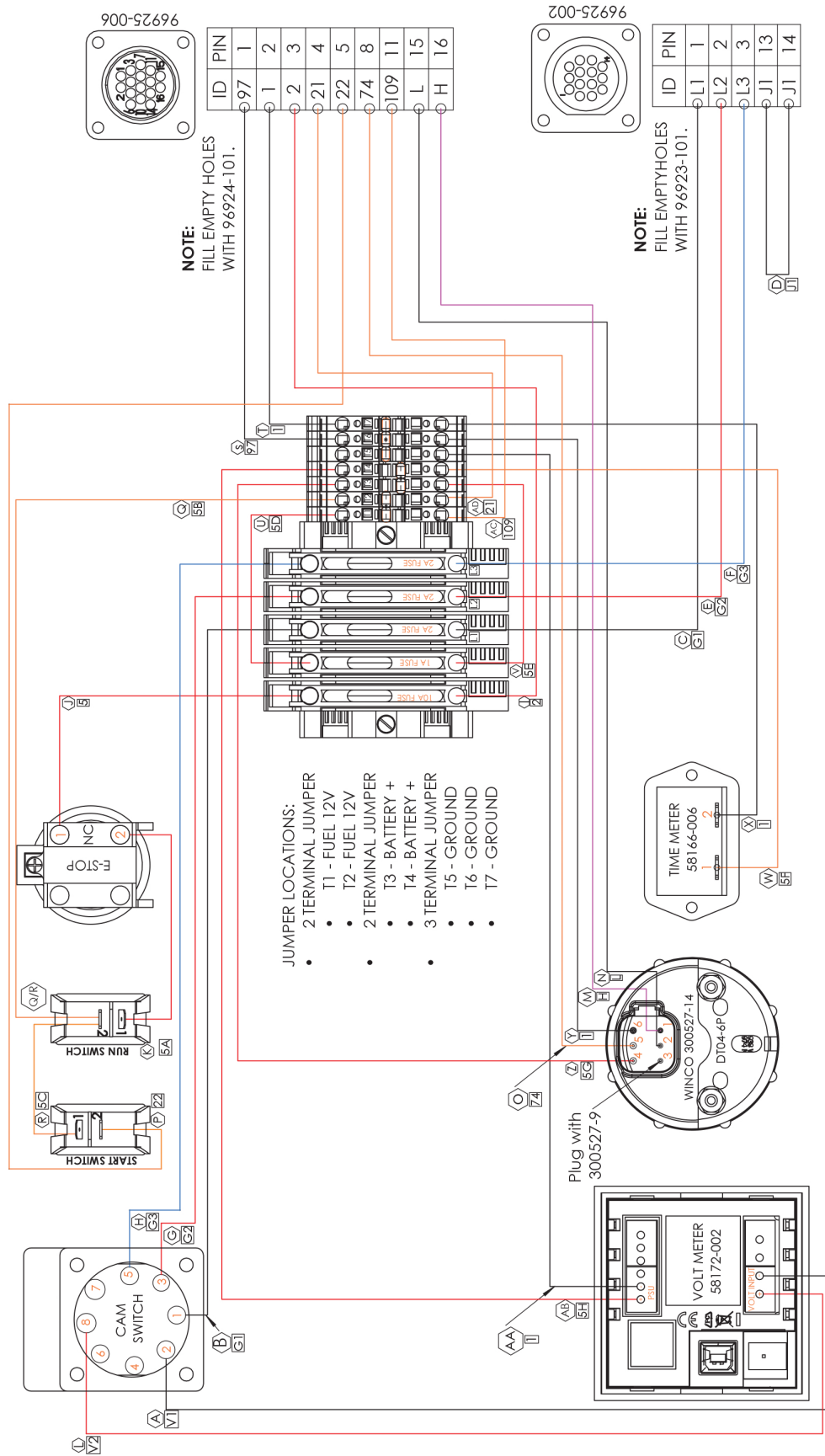

DSE7310 WIRING DIAGRAM

LEGEND:
 PS: POWER SWITCH
 ESS: EMERGENCY STOP SWITCH
 FSS: FUEL SELECTION SWITCH
 VAR: VOLTAGE ADJUSTMENT RHEOSTAT

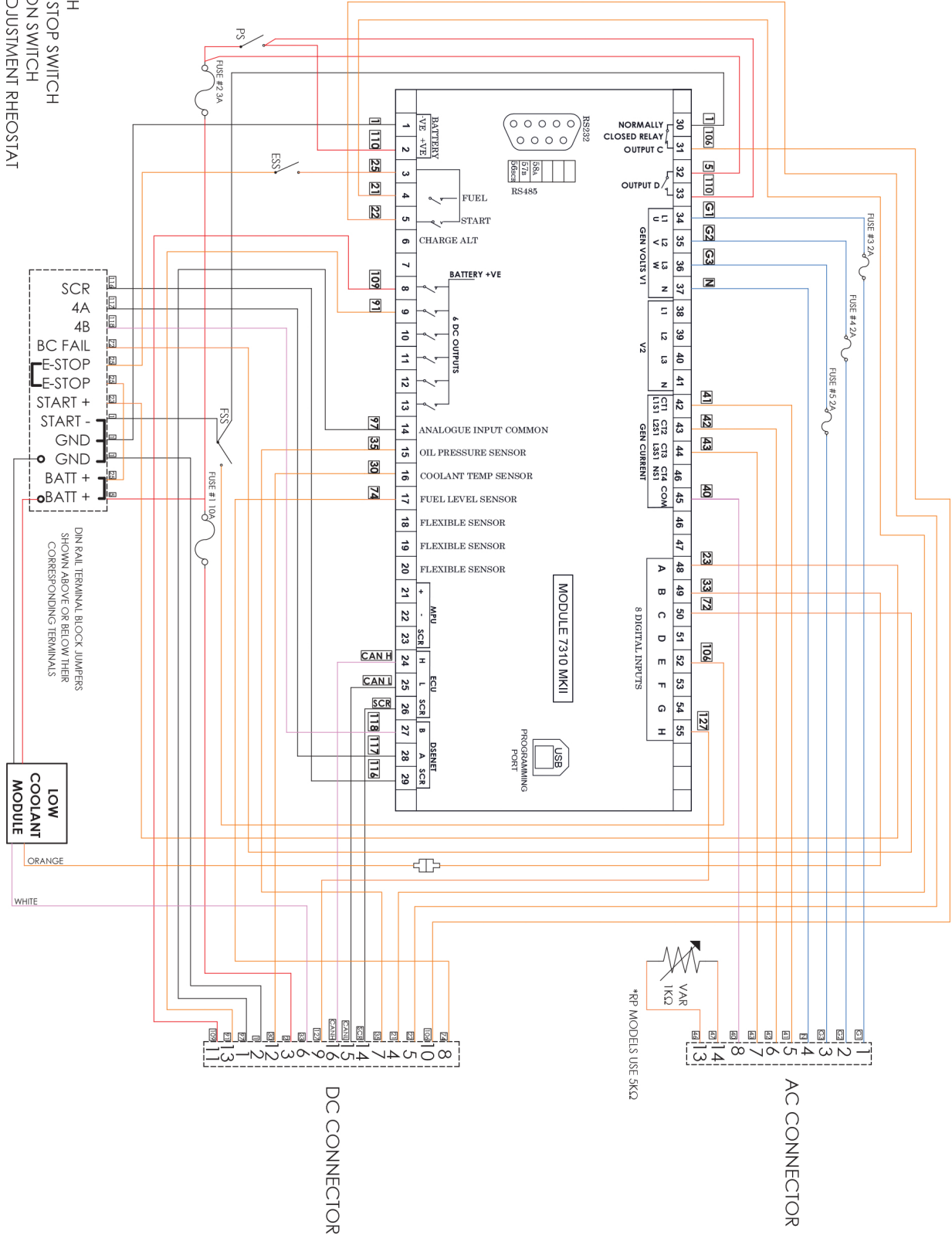

CALIFORNIA EMISSION CONTROL WARRANTY STATEMENT

YOUR WARRANTY RIGHTS AND OBLIGATIONS

California Air Resources Board and FPT Industrial S.p.A. are pleased to explain the emission control system warranty on 2021 to 2023 off-road engines. In California, new heavy-duty off-road engines must be designed, built, and equipped to meet the state's stringent anti-smog standards. FPT Industrial S.p.A. must warrant the emission control system on your engine for the periods of time listed below provided there has been no abuse, neglect, or improper maintenance of your engine.

Your emission control system may include parts such as the fuel injection system and the air induction system. Also included may be hoses, belts, connectors, and other emission-related assemblies.

Where a warrantable condition exists, FPT Industrial S.p.A. will repair your heavy-duty off-road engine at no cost to you including diagnosis, belts, connectors, and labor.

MANUFACTURER'S WARRANTY COVERAGE:

The 2021-2023 heavy-duty off-road engines are warranted for 5 years or 3000 hours, whichever comes first. If any emission-related part on your engine is defective, the part will be repaired or replaced by FPT Industrial S.p.A.

OWNER'S WARRANTY RESPONSIBILITIES:

- As the off-road engine owner, you are responsible for the performance of the required maintenance listed in your owner's manual. FPT Industrial S.p.A. recommends that you retain all receipts covering maintenance on your off-road engine, but FPT Industrial S.p.A. cannot deny warranty solely for the lack of receipts or for your failure to ensure the performance of all scheduled maintenance.
- As the off-road engine owner, you should however be aware that FPT Industrial S.p.A. may deny your warranty coverage if your off-road engine or part has failed due to abuse, neglect, improper maintenance or unapproved modifications.
- Your engine is designed to operate on diesel only. Use of any other fuel may result in your engine no longer operating in compliance with California's emissions requirements.
- You are responsible for initiating the warranty process. The ARB suggests that you present your off-road engine to a FPT Dealer as soon as problems exist. The warranty repairs should be completed by the dealer as expeditiously as possible.

If you have any questions regarding your warranty rights and responsibilities, you should contact NAFTA Technical Service Group at 1-630-481-2905 or email: fpt-na-warranty@fptindustrial.com

CALIFORNIA EMISSION CONTROL WARRANTY PARTS LIST

Fuel injection system

- Fuel injection part
- Fuel injectors
- Fuel injection lines

Positive Crankcase Ventilation (PCA) system (if applicable)

- PCV valve
- Oil cap filler

Exhaust Gas Recirculation Systems (EGR)

- EGR valve assembly
- EGR Cooler

Exhaust after treatment devices (if applicable)

- Diesel Oxidation Catalyst (DOC)
- Diesel Particulate Filter (DPF)
- Selective Catalytic Reduction (SCR)
- Diesel Exhaust Fluid (DEF) tank and dispensing systems

Air induction system

- Intake manifold
- Turbocharger system (includes exhaust manifold)
- Charger air cooled

Cold Start Enrichment Systems

Electronic Control Units, Sensors, Solenoids, and Wiring harnesses used in above systems

Miscellaneous items used in above systems, such as hoses, belts, connectors, tubing, gaskets, and mounting hardware

Emission Control Information Labels

US ENVIRONMENTAL WARRANTY STATEMENT

FPT Industrial S.p.A. warrants to the ultimate purchaser and each subsequent purchaser that the engine is designed, built, and equipped so as to conform with US Environmental Protection Agency (EPA) regulations applicable at the time of manufacture and that it is free from defects in workmanship or material which would cause it not to meet these regulations for a period of time:

2 years or 1,500 hours of operation, whichever occurs first, for engines less than 19kW (25HP)

5 Years or 3,000 hours of operation, whichever occurs first, for engines greater than or equal to 19kW (25 HP)

Note: This warranty applies to all units operated in the United States and Canada.

COVERAGE:

The model year, class of engine, and emission application determination for your engine are identified on the Emission Control Information Label. This label is affixed to one of the following areas of the engine: the top of the engine's rocker arm cover, the right-hand side of the oil pan, and the right-hand side of the engine's front gear cover. The warranty period begins on the date the new equipment is sold to the first retail purchaser. The presence of the emission control label is the indication that the engine conforms to the applicable standards. Any emission control system parts which are proven defective during normal use will be repaired or replaced during the warranty period.

The engine owner has responsibility to perform all the required maintenance listed in the Owner's Manual. FPT Industrial S.p.A. will not deny an emission warranty claim solely because no record of maintenance exists; however, a claim may be denied if failure to perform maintenance resulted in the failure of the warranty part.

It is recommended that replacement parts used for maintenance or repairs be FPT Industrial S.p.A. service parts to maintain the quality originally designed into your emission certified engine. The use of non-FPT Industrial S.p.A. parts does not invalidate the warranty on other components unless the use of such parts causes damage to warranted parts.

The manufacturer is liable for damages to the other engine components caused by the failure of any warranted emission control system part. FPT Industrial S.p.A. is not responsible for failures resulting from improper repair or the use of parts that are not genuine FPT Industrial S.p.A. or FPT Industrial S.p.A. approved parts.

COMPONENT COVERAGE:

New engines certified for sale and registered will have the following items covered by the emission warranty, depending on the emission level of the engine, if the items were first installed on the new engine as original equipment.

<ul style="list-style-type: none"> Fuel injection system Fuel injection part Fuel injectors Fuel injection lines 	<ul style="list-style-type: none"> Air induction system Intake manifold Turbocharger system (includes exhaust manifold) Charger air cooler
<ul style="list-style-type: none"> Positive Crankcase Ventilation (PCV) system (if applicable) PCV valve Oil cap filler 	<ul style="list-style-type: none"> Exhaust after treatment devices (if applicable) Diesel Oxidation Catalyst (DOC) Diesel Particulate Filter (DPF) Selective Catalytic Reduction (SCR) Diesel Exhaust Fluid (DEF) tank and dispensing systems

REVALIDATION OF WARRANTY

FOR LONG-TERM STORAGE OF ENGINES

If any engine has not been sold to the end user prior to nine (9) months after the manufactured build date of the engine, the seller must revalidate each engine at this time, and every twelve (12) months afterwards for a maximum of 33 months from engine manufacture date for warranty coverage to be available, and provide written confirmation to WINCO Inc that the engine was revalidated. Warranty will be exhausted if the unit is still in the seller's inventory after revalidation cycle.

Refer to your Winco Dealer and the Engine manufacturer literature for the required procedures to prepare your engine for long-term storage, and also for startup procedures after the storage period. Dated Service records indicating that the requirements have been performed must be maintained. Failure to comply with these storage requirement procedures may revoke consignment privileges, and limit and/or void the applicable warranty on the engine.

LIMITED WARRANTY

WINCO Incorporated warrants to the original purchaser for the warranty period that goods manufactured or supplied by it will be free from defects in workmanship and material, provided such goods are installed operated and maintained in accordance with WINCO written instructions.

WINCO's sole liability, and Purchaser's sole remedy for a failure under this warranty, shall be limited to the repair of the product. At WINCO's option, material found to be defective in material or workmanship under normal use and service will be repaired or replaced. For warranty service, contact a Winco Authorized Service Center within the warranty period from date of purchase.

*NOTE: Units that are resold by original owner are not covered under this warranty. Any further warranty, whether expressed or implied, rests solely with the reseller.

THERE IS NO OTHER EXPRESS WARRANTY.

To the extent permitted by law, any and all warranties, including those of merchantability and fitness for a particular purpose, are limited to the warranty period from date of purchase. In no event is WINCO liable for incidental or consequential damages.

Note: Some states do not allow limitation on the duration of implied warranty and some states do not allow the exclusion or limitation of incidental or consequential damages, so the above limitations may not apply in every instance. This warranty gives you specific legal rights which may vary from state to state.

WINCO, INC. WARRANTY EFFECTIVE DATE

Air cooled units purchased for stock have 1 year to be sold. The warranty to the original retail customer commences on the date of sale of the product to them. All liquid cooled units have 180 days from the Winco invoice to submit a start up date. If no startup form is submitted, then warranty period starts on the Winco invoice date unit was sold.

Date of sale is defined as the day the customer takes delivery of the product. This warranty shall remain in effect to the original purchaser for the period stated on the sales literature. The warranty is not transferable and the retail customer must retain his original bill of sale as proof of purchase date.

WINCO, Inc. agrees to the following obligations during the warranty period:

1. To warrant any defect in material or workmanship of products sold under the WINCO and DYNA brand names in accordance with the warranty statements in the operator's manuals.
2. To reimburse authorized WINCO, Inc. Service Centers/Dealers for the cost of parts plus standard ground UPS shipping charges for all valid warranty repairs and to reimburse same said service centers/dealers for reasonable labor charges based on WINCO's current warranty labor reimbursement rate.
3. To furnish its authorized service centers/dealers with the necessary parts to make the repairs. WINCO Generator Warranty Periods & Restrictions

WINCO GENERATOR WARRANTY PERIODS & RESTRICTIONS

Industrial Portables

WL Models - 3 Years, See Notes 1 & 2

W Models - 3 Years, See Notes 1, 2, & 5

DP Models - 3 Years, See Notes 1 & 2

HPS Models - 2 Years, Home Use ONLY; Commercial use* is 90 Day Warranty, See Note 1

EMERGEN-C (EC) Series

2 Years, See Note 1

DE Series

1 Year/2000 hours, No Travel Time

Mobile Diesel Series

1 Year/2000 hours, No Travel Time

PTO Series

15kW & 10kW - 1 Year, Limited Farm Standby Only

25kW thru 165kW - 3 Years, Limited Farm Standby Only/Commercial use* 1 Year

Two Bearing Series

1 Year, Bench Labor and Parts only

Gaseous/Packaged Standby Series (PSS)

Air-Cooled Models (PSS8, PSS12, & PSS20) – 2 Years/2000 Hours Standby Only See Notes 3 & 4 Prime Power use 1 Year/2000 Hours See Notes 3 & 4

Liquid-Cooled Models (PSS21 - PSS150) - 2 Years/2000 Hours Standby Only See Notes 3 & 4 Prime Power use 1 Year/2000 Hours See Notes 3 & 4

Diesel Standby Series (DR)

Liquid-Cooled Models (DR12 - DR600) - 2 Years/2000 Hours Standby Only See Notes 3 & 4

Prime Power use 1 Year/2000 Hours See Notes 3 & 4

Accessories (Installed on Generator or shipped loose)

1 Year from factory invoice or 2000 Hours (whichever occurs first)

OPM-143/J

Automatic Transfer Switches (ATS)

See ATS Manufacturer's Warranty

NOTES

Note 1: First 2 years of warranty coverage includes Parts and Bench Labor Only, no travel time or labor allowance for removal or reinstallation of the product from its application.

Note 2: 3rd Year warranty coverage is parts only/no labor.

Note 3: Round trip mileage is limited to 200 miles per trip and a total of 2 trips per repair unless authorized in writing by the WINCO Service Dept.

Note 4: Mileage allow on permanently installed units only. Trailer mount units is bench labor only.

Note 5: W3000 is a 1 Year Warranty.

*Commercial use is defined as Construction, Rental, Prime Power, or use in a business of any type including agricultural and hobby. Prime Power use is defined as any application where the generator set is being used 'off-grid' where there is no utility power present. Standby use is defined as an application where utility power is present -and- the generator set is used as emergency backup during utility power outages.

WINCO reserves the right to change or improve it's products without incurring any obligations to make such changes or improvements on products purchased previously.

EXCLUSIONS:

WINCO does not warrant Engines. Engines are covered exclusively by the warranties of their respective manufacturers.

WINCO does not warrant Batteries, or Other Component Parts that are warranted by their respective manufacturers.

WINCO does not warrant modifications or alterations which were not made by WINCO, Inc.

WINCO does not warrant products which have been subjected to misuse and/or negligence or have been involved in an accident.

This warranty does not include travel time, mileage, or labor for removal or reinstallation of WINCO product from its application, unless specifically authorized.

WHAT IS COVERED BY WARRANTY

1. Generator end including rotor, stator, end brackets, and bearing.
2. Control box including transformers, circuit breakers, wiring, resistors, and switches.
3. LP/NG fuel system including fuel solenoid, demand regulator, carburetor, and hoses.
4. Cradle assembly including cradle, cross member, and shock mounts that fail. Shock mounts damaged from rough handling are not covered.
5. Reasonable travel time for the PSS & DR series generators only, that are permanently installed.
6. Ground shipping charges for warranty parts, no premium service, domestic US shipments only.

WHAT IS NOT COVERED BY WARRANTY

1. Products which have been subjected to alteration, modification, neglect or unauthorized repairs not approved in writing by Winco, Inc.
2. Products no longer owned by the original purchaser.
3. Products with shipping or freight damage. File a freight claim with the delivery carrier.
4. Products suffering normal wear, accidents, improper maintenance or improper protection in storage. Products damaged by rough handling, such as shock mounts on cradle assemblies.
5. Pressure or steam cleaning of products, cleaning of fuel system, or flushing of cooling system.
6. Replacement of filter, belts, antifreeze, or lubricants.
7. Electrical items, such as light bulbs, receptacles, spark plugs, or any items damaged by welding or jump starting.
8. Any repeat or shop come-back repairs resulting from poor service work or improper diagnosis and testing. Replacement of parts as a trial-and-error method of diagnosis will not be considered for warranty.
9. Replacement parts other than those sold by Winco, Inc.
10. Damage caused by fire, flood, lightning or any other natural disaster.
11. Damage caused by improper protection during installation, (i.e. not protecting contactor in the ATS panel and getting wire trimming or debris from drilling the box in the contactor coil or contacts.)
12. Damage caused by over loading of the generator and failure to adequately provide overload protection.
13. LP/NG fuel adjustments or conversion from one fuel to another.
14. Adjustment of any kind, all units are 100% load tested before shipping.
15. Any damage caused by the use of the equipment for purposes other than for which it was designed.
16. Engines - All engines used by Winco, Inc. are warranted by their respective manufacturer's.
17. Batteries - Must be returned to original battery manufacturer.
18. Damage caused by improper installation or failure to provide adequate ventilation.
19. Cosmetic repairs, such as repainting.
20. Freight charges for transportation to and from a Warranty Service Center.
21. Rental costs of renting replacement generators.
22. Travel time or service calls unless specifically authorized by Winco, Inc. in writing.

GENERAL INFORMATION

The WINCO, Inc. Service Department is open from 7:30 AM to 4:30 PM Central Standard time.

It is located at 225 South Cordova Ave., Le Center, MN, 56057-1805.

Phone Numbers: Service Department - 507-357-6831 FAX Line - 507-357-4857. Email address is service@wincogen.com

The phone number to for the General Switchboard/Sales Department is 507-357-6821.

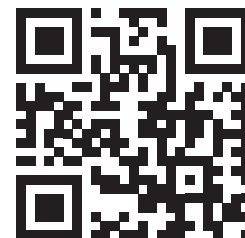

WINCO[®]
GENERATORS



AN AMERICAN COMPANY

225 S. CORDOVA AVE • LE CENTER, MN 56057

Sales: 507-357-6821 • sales@wincogen.com

Service: 507-357-6831 • service@wincogen.com

www.wincogen.com